

ISSUE 12

VOLUME 14

DECEMBER 2024

# ASPIRE

ACHIEVEMENTS IN SPORTS, PROJECTS, INDUSTRY, RESEARCH AND EDUCATION



DEPARTMENT OF MECHANICAL ENGINEERING



SRI SIVASUBRAMANIYA NADAR COLLEGE OF ENGINEERING  
RAJIV GANDHI SALAI(OMR), KALAVAKKAM, CHENNAI, TAMIL NADU, INDIA

# From the HoD's desk.....



**Dr. K S Vijay Sekar**

Professor and Head,  
Department of Mechanical  
Engineering

We are happy to share the December edition of Aspire!!

We profile Kailash Satyarthi who was awarded the Nobel peace prize for his incessant work in eliminating child labour. It's heartening to note that Shiv Nadar and his family have been recognized as India's most generous philanthropists for the 3rd time in 5 years by EdelGive-Hurun.

Dr S Radha takes over as the Principal of SSN and Dr VE Annamalai who superannuated as Principal, SSN has been appointed as Vice-president, Higher education of SSN/SNU, the information being shared by our President SSN and Pro chancellor SNU Chennai – Dr Kala Vijayakumar. On behalf of the Mechanical Engineering department, we wish both of them the very best in their new roles

Our students continue their good performance in placements with offers from Dow chemicals, Yamaha and Cognizant. Faculty continue their good run in publishing noteworthy journals. The department organized a workshop on Novel materials and processing, while one of our faculty was a jury in a hackathon event. I had an opportunity to deliver a soft skill training for our I year students across three days and it was invigorating to note the enthusiastic participation of the students and their motivation towards fulfilling their career aspirations in SSN. Our student shares his enriching experience at Motherson company, while one of our alumni shares her journey to Purdue university, USA and another shares her outing at IIM Raipur for her MBA and now with Vedanta Aluminium.

Best Wishes for a cool December,  
KSV

[vijaysekarks@ssn.edu.in](mailto:vijaysekarks@ssn.edu.in)

PS – Hoping to see our Mech alumni at the annual Tribute event in January in large numbers!!!

# Kailash Satyarthi: Tireless Advocate for Child Rights

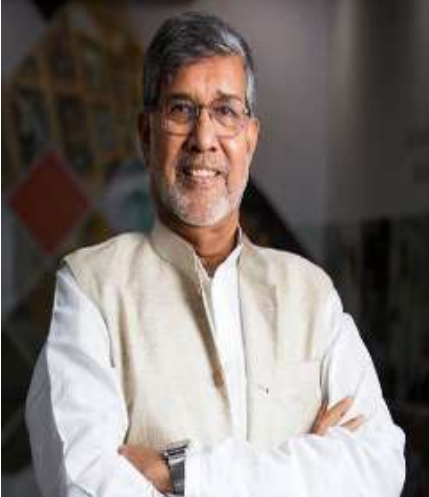

Kailash Satyarthi, born on January 11, 1954, in Vidisha, India, is a globally respected child rights activist and Nobel Peace Prize laureate. He was awarded the Nobel Peace Prize in 2014, alongside Malala Yousafzai, for his lifelong dedication to combating child labor and advocating for universal access to education. Satyarthi's work has liberated thousands of children from bonded labor, slavery, and exploitation, making him a pivotal figure in the global fight for children's rights and dignity.

Satyarthi's passion for social justice emerged early in his life. He studied electrical engineering at Samrat Ashok Technological Institute in Vidisha but soon transitioned to activism, driven by the pervasive injustice he witnessed around him. In 1980, he founded the Bachpan Bachao Andolan (Save Childhood Movement), which has since rescued over 100,000 children from slavery, trafficking, and exploitative labor conditions. His grassroots approach combines direct rescue missions with community awareness and policy advocacy, ensuring sustainable change for the affected children and their families. One of Satyarthi's landmark achievements is his role in advancing legislation and international conventions against child labor. He was instrumental in the adoption of Convention 182 by the International Labour Organization (ILO), which prohibits the worst forms of child labor. Through his Global March Against Child Labour, he mobilized millions of people across 103 countries to demand stronger global efforts to protect children. His work has fundamentally reshaped international norms, making the eradication of child labor a priority for governments and organizations worldwide.

Satyarthi emphasizes education as the cornerstone of empowerment and liberation. His campaigns stress the importance of free, quality education for all children, viewing it as a critical tool to break the cycle of poverty and exploitation. He has also highlighted the interconnectedness of child rights with broader social issues, advocating for gender equality, fair wages, and sustainable development to address the root causes of exploitation.

Satyarthi has received numerous accolades throughout his distinguished career, including the Nobel Peace Prize, the Defenders of Democracy Award, and recognition from several international organizations for his unwavering commitment to justice. His efforts have inspired global movements, catalyzing change across communities, industries, and nations.



## SHIV NADAR : INDIA'S MOST GENEROUS PHILANTHROPIST

The EdelGive-Hurun India Philanthropist List has once again recognized Shiv Nadar and his family as India's Most Generous Philanthropist, marking the third time in five years they have achieved this honor. This accolade highlights their unwavering commitment to giving back to society through impactful initiatives. As the founder of the Shiv Nadar Foundation, Shiv Nadar has championed the cause of Creative Philanthropy, focusing on transformative efforts in education, research, and innovation. Their efforts have created institutions that drive socio-economic progress and empower countless individuals. This recognition underscores the Nadar family's dedication to creating a lasting legacy of generosity, setting a benchmark for others to follow in shaping a brighter, equitable future for India.

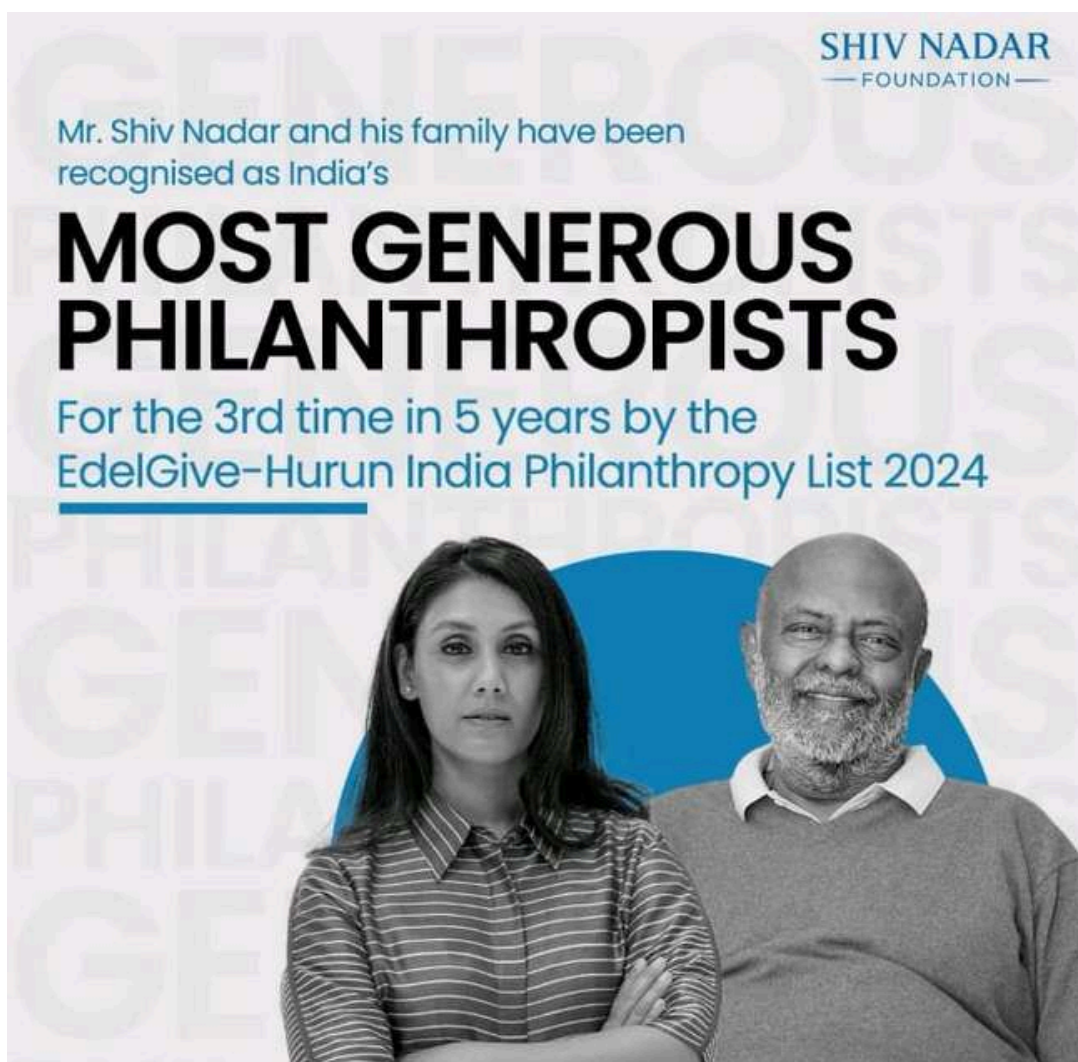

## SSN COLLEGE OF ENGINEERING TRIUMPHS AT ANNA UNIVERSITY SQUASH EVENT

Heartiest congratulations to the team from SSN College of Engineering for securing first place in the prestigious Anna University Squash Event! This remarkable achievement reflects their relentless dedication, hard work, and exceptional sportsmanship.

Competing against some of the finest talents from across the state, the team demonstrated outstanding skill and teamwork, proving their mettle on the court. Their victory is not just a testament to their athletic prowess but also to the unwavering support and encouragement provided by the institution.

This accomplishment brings pride to the SSN community and serves as an inspiration for future athletes. Kudos to the entire team for their exceptional performance and for bringing home this well-deserved honor!





A. Surya, R. Prakash, N. Nallusamy." Experimental study on the charging and discharging performance of a thermal energy storage unit using low temperature phase change material." Journal of Energy Storage. 103(2024),pp 1-21. Clarivate Impact Factor: 8.9.

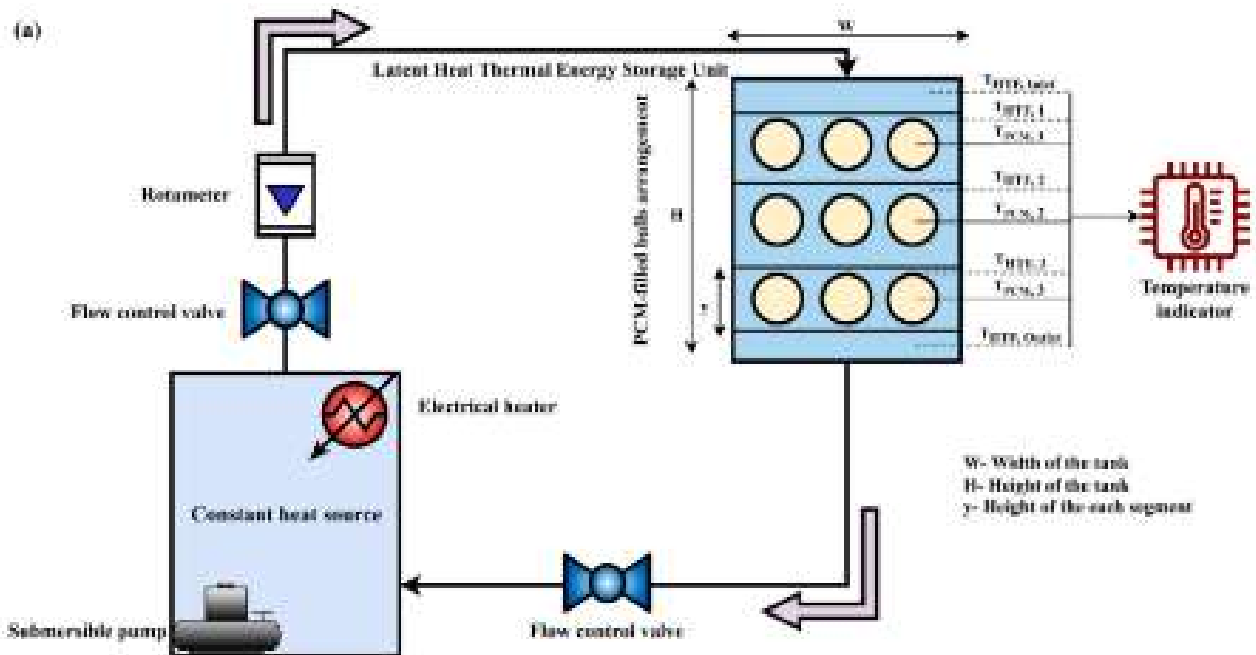

Fig. 1. Schematic layout of the LHTES unit.



K. Ravi, M. Matheswaran , and S. A. Srinivasan. "Effect of Limestone Addition to Coal on SO<sub>2</sub> Emission Control and Erosion-Corrosion Behaviour of Rifle Bore Bed Tube in AFBC Boiler." Solid Fuel Chemistry. Vol. 58, No. 5, pp. 408–414 Clarivate Impact Factor: 0.8

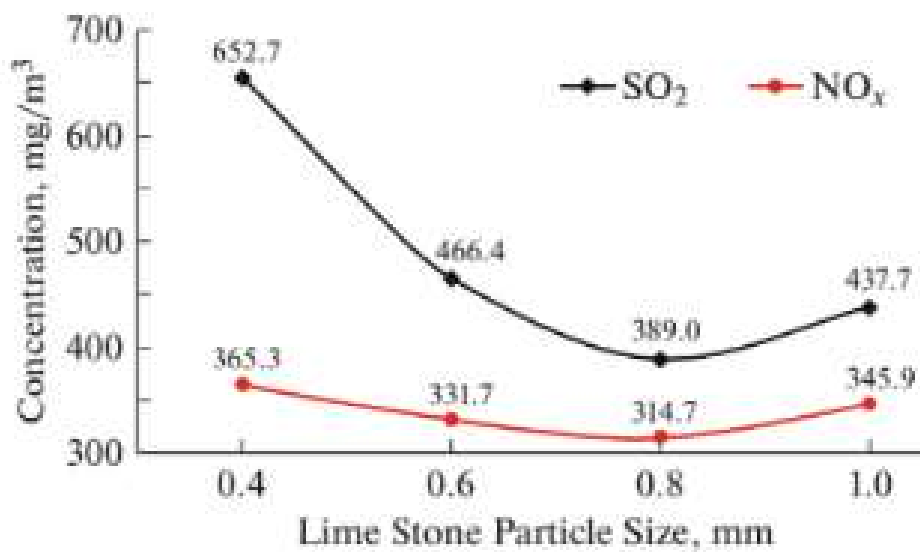

Fig. 2. Effect of limestone particle size on the SO<sub>2</sub> and NO<sub>x</sub>.

M. Sunil Kumar , S. A. Srinivasan , M. S. Alphin , B. Mustafa and Senthil Kumaran Selvaraj.”Progresses in the NO X Elimination Using Zeolite Under Low-Temperature Ammonia-Based Selective Catalytic Reduction—A Review.” Advances in Materials Science and Engineering. Volume 2024, Pg no 1-16. Clarivate Impact Factor: 2.98.

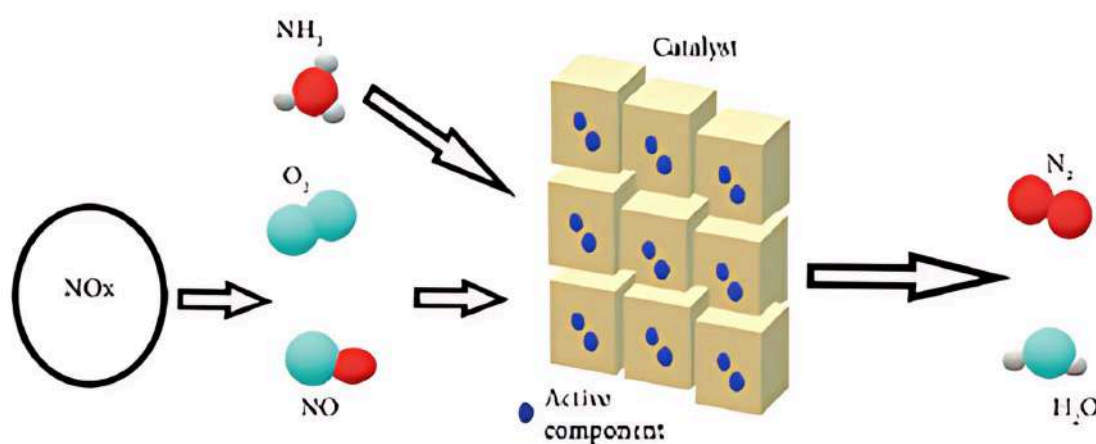

FIGURE 1:  $\text{NH}_3$ -SCR mechanism.

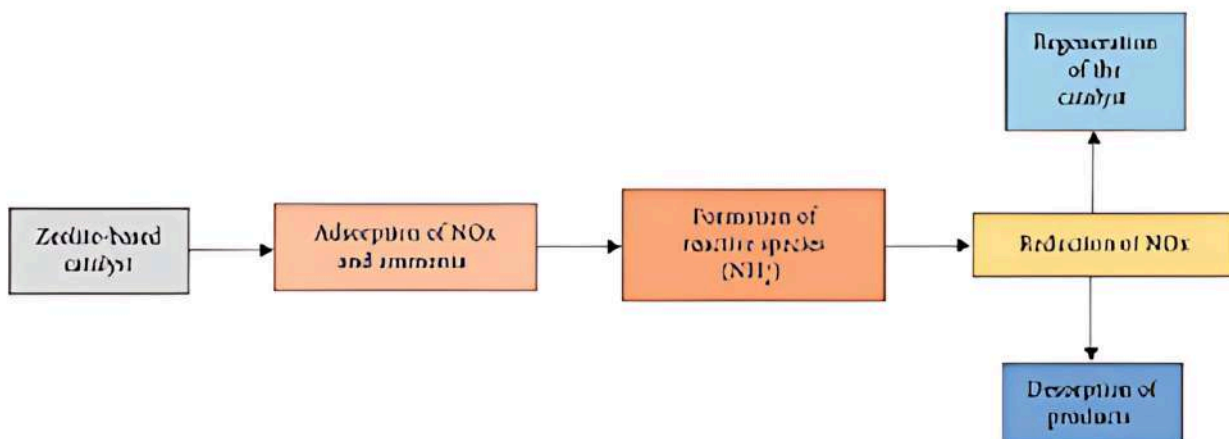

FIGURE 2: Mechanism of zeolite.



## DEPARTMENT OF MECHANICAL ENGINEERING CLASS OF 2025

### PLACEMENT UPDATE

DOW CHEMICALS



ABIRAMI SUBBIAH



RISHI KRANTI R



RAKESH KUMAR

## DEPARTMENT OF MECHANICAL ENGINEERING CLASS OF 2025

### PLACEMENT UPDATE



VIGNESH V S



ABHISHEK KUMAR



K.E.VISWARAM



SOORIYA PRASAATH  
M S



SUCHITHRAA PK



SINDHU M

# ONE DAY NATIONAL WORKSHOP ON NOVEL MATERIALS AND PROCESSING

The Department of Mechanical Engineering organized a one-day national workshop on "Novel Materials and Processing" on 21 December 2024 coordinated by Dr. S. Santosh, Dr. M. Dhananchezian, and Dr. S. Suresh Kumar. The workshop aimed to provide participants with insights into advanced materials and their processing techniques, focusing on their applications in modern engineering challenges. The workshop witnessed active participation from second-year Mechanical Engineering students, who engaged enthusiastically throughout the sessions.

The workshop was divided into two interactive sessions: For the first session, Dr. S. Santosh delivered a comprehensive lecture on Shape Memory Alloys (SMAs). His session covered the fundamentals, properties, and practical applications of SMAs in industries such as aerospace, automotive, and biomedical engineering. The session included engaging examples and case studies, offering students a deeper understanding of these smart materials. And for the second session, Dr. S. Suresh Kumar conducted the afternoon session on the Failure of Materials. His discussion highlighted the various modes of material failure, testing techniques, and preventive measures. Students gained practical insights into failure analysis, a critical aspect of design and manufacturing processes.



The key highlights are the interactive Q&A sessions in both sessions saw enthusiastic participation, reflecting the students' keen interest and real-world examples and multimedia presentations enriched the learning experience.

The workshop concluded with a vote of thanks, acknowledging the efforts of the coordinators, speakers, and participants. The students appreciated the workshop for its practical relevance and its alignment with emerging trends in material science and engineering. This workshop served as an excellent platform to enhance knowledge and foster a deeper understanding of novel materials and their significance in engineering applications.

## DR K S JAYAKUMAR ACTED AS JURY MEMBER IN LTTS OPEN HACK CHENNAI

Dr. K. S. Jayakumar acted as a Jury member in LTTS Chennai Open Hack, organized by L&T Technology Service, Chennai on 08/11/2024.



## DR K S VIJAY SEKAR CONDUCTS SOFT SKILLS TRAINING FOR FIRST-YEAR STUDENTS



I am thankful to the institution in general and CDC in particular for giving me an opportunity to train a section of the 1 year batch on Soft Skills between 4th and 6th December 2024. Over the three days ( 2-3.30 pm daily) I was able to interact with about 9 sections of students cut across different departments. I focused on the need to develop effective communication, interpersonal and time management skills that were essential ingredients towards a successful placement or a higher study offer. It was an interactive and lively session with good response from the students, who found it useful and career oriented. Hope to interact with such an enthusiastic audience in times to come. It was a rewarding and inspiring experience.

## FDP ATTENDED

<p>04/11/2024 to 08/11/2024</p>	<p>Dr.R.Prakash, Associate Professor, attended National Level 5-Day Online Faculty Development Programme on "Metal Additive Manufacturing: From Advances to Adaptability", Conducted by St. Joseph's Institute of Technology, Chennai from 04.11.2024 to 08.11.2024.</p>
-------------------------------------	--

## SCHOLAR INFO

<p>13/11/2024</p>	<p>Dr KS Vijay Sekar, Prof&amp;Head, conducted the 4th DC meeting to review examiners report for Mr K Gobivel, Part time scholar, on 13.11.2024</p>
<p>27/10/2024</p>	<p>Dr KS VijaySekar's full time scholar R Aarthi was awarded the PhD degree certificate in the Anna University convocation held on 27.10.2024</p>
<p>04/11/2024</p>	<p>Dr. Poovazhagan L, ASP/Mech conducted the confirmation DC Meeting for his part-time research scholar, Mr Saravanan K on 04.11.2024.</p>



## INTERNATIONAL JOURNAL PUBLICATION

02/11/2024	A. Surya, R. Prakash, N. Nallusamy have published a paper titled “Experimental study on the charging and discharging performance of a thermal energy storage unit using low temperature phase change material” in the journal ‘Journal of Energy Storage’.
26/11/2024	K. Ravi, M. Matheswaran , and S. A. Srinivasan have published a paper titled “Effect of Limestone Addition to Coal on SO <sub>2</sub> Emission Control and Erosion-Corrosion Behaviour of Rifle Bore Bed Tube in AFBC Boiler” in the journal ‘Solid Fuel Chemistry’.
26/11/2024	M. Sunil Kumar , S. A. Srinivasan , M. S. Alphin , B. Mustafa and Senthil Kumaran Selvaraj have published a paper titled “D Progresses in the NO <sub>x</sub> Elimination Using Zeolite UnderLow-Temperature Ammonia-Based Selective CatalyticReduction—A Review” in the journal ‘Advances in Materials Science and Engineering’.

## NON-TEACHING STAFF ACTIVITIES

27/11/2024	Mr.Balasundaram.Palanisamy / Assistant Lab Instructor / Mechatronics & Automation laboratory / MECH attended one day webinar _ Creo Parametric Fundamentals - Part 2 17.10.2024 _ Tuesday 2 to 3 pm through Online platform.
------------	--

## MANI MATHESH FROM 3RD YEAR WRITES...

I recently had the privilege of visiting the Motherson Group facility in Chennai, and it was a truly enlightening experience. Known for its excellence in the automotive sector, the facility carries out several critical manufacturing processes. Among the key activities are Manufacturing Wiring Harnesses, which form the backbone of vehicle electrical systems, and Injection Molding and Tooling, essential for creating precision plastic components. The company also excels in Automotive Mirror Systems, delivering high-quality mirrors that enhance vehicle safety. Additionally, I observed their work in producing Modules and Polymer Products, which are integral to both the interiors and exteriors of automobiles. The visit provided me with valuable knowledge about advanced technologies and efficient production techniques in the automotive industry.



## NANDITA SURESH OF MECH'22 SHARES...

Nanddita Suresh (Mech22) pursuing master's at Purdue University



I'm beyond thrilled to announce that this Fall, I will be starting a new chapter at Purdue University, pursuing Master's in Industrial Engineering!

This post also marks the celebration of my two incredible years at Dow. Joining DOW as a fresh graduate from SSN College of Engineering was both exciting and nerve-racking, but the journey has been transformative, shaping me into the professional I am today. A heartfelt thanks to all my wonderful mentors and colleagues at DOW for their invaluable guidance and support. The experiences and knowledge I've gained will always be cherished.

I am deeply honored to have received admissions from other prestigious universities, including Georgia Tech H. Milton Stewart School of ISyE, University of Michigan, University of Wisconsin-Madison, Texas A&M University, and Arizona State University. Each offer was a testament to my hard work and dedication.

Receiving my admission to the prestigious Purdue University for its renowned industrial engineering program is truly a dream come true. Growing up, I always aspired to study at one of the top schools, and today, I am overjoyed to see that dream come to fruition. It was a challenging journey, but a rewarding one! This achievement wouldn't have been possible without the unwavering support of my parents, friends, professors and seniors. I extend my heartfelt thanks to everyone for their guidance and enthusiastic support.

I am eager to embrace this new challenge and continue my growth at Purdue University Edwardson School of Industrial Engineering. I am extremely excited to collaborate and work with my professors, industry experts and fellow students to expand my knowledge and learn together. Here's to a new chapter and a wholesome professional transformation!

## VITHYA OF MECH'21 SHARES...

Vithya (Mech21) Working at vedanta Aluminium Shares



My SSN Journey and Beyond!

As I look back, I realize SSN College of Engineering was where it all began. Graduating in 2021 with a Mechanical Engineering degree, I cherish the memories and experiences that made me who I am today. At SSN, academics and extracurriculars blended perfectly.

Faculty guidance helped me build a strong engineering foundation, while the emphasis on innovation sparked my business interest, leading me to IIM Raipur for my MBA.

Beyond academics, I engaged in various extracurricular activities, including InvenTe, Sports Fest where I represented SSN in Badminton, and an Internal Funded Project (IFP) that fostered innovative research and development. These experiences taught me teamwork, problem-solving, adaptability, and time management. SSN's supportive ecosystem encouraged risk-taking, exploration, and growth.

Post-MBA, I joined Vedanta Aluminium in the supply chain management, applying technical and business skills to drive growth. My role involves navigating complex supply chains, fostering relationships, and contributing to the company's growth.

"SSN taught me to embrace challenges. I'm forever grateful for the friendships, the laughter, and the invaluable lessons I've gained along the way."

To fellow SSN alumni and students: SSN is your launchpad—make the most of its resources, seek guidance, and embrace risks. Your journey is unique, and your successes will be shaped by the lessons you learn here. Stay connected, stay proud, and keep reaching new heights!

## No Competition, No Progress

### Indiapreneur 14.0

(Indira School of Business Studies PGDM)

[Link: Register here](#)

INDIRA SCHOOL OF BUSINESS STUDIES PGDM

**INDIAPRENEUR 14.0**  
National Level Business Plan Competition

Win prizes worth **₹100,000+**

**Dare to DISRUPT**

Last Date for Registration: **15<sup>th</sup> Jan, 2025**

Sponsored by

Winner: 1<sup>st</sup> Runner Up 2<sup>nd</sup> Runner Up

ORAH VISA Finlatics

indiapreneur@indiraibs.ac.in

### EcoMatrix

(Indian Institute of Technology Madras)

[Link: Register Here](#)

**ECOMATRIX**  
The Economics event

Prize Pool-Rs 30,000

Registration Deadline: 8th December 2024

Venue: Online

Register Now Via: Unstop

For More info, contact: Indresh - 9369466365 | Chitharth - 8248605531

### AtomQuest 2024

(Atomberg Technologies Pvt. Ltd.)

[Link: Register Here](#)

atomberg x SHAASTRADIGS

**atomQUEST**  
2024  
THE ULTIMATE TECH COMPETITION

REVOLUTIONIZE MECH-ELECTRONICS SOLUTIONS

Prizes worth **₹2,00,000/-**

Pre-placement Interview

**REGISTER NOW!**



## *From the desk of Ramki – Aspire to Inspire*

From Ramki  
Happy Morning – Aspire to Inspire

### Discipline

The world discipline sounds like an alarm bell in people's minds. The dictionary defines the word 'Discipline' as regulations, order, systematic training. Discipline also means giving yourself no choice or fall-back options, being tough on yourself, etc. Apart from all these meanings and definitions, we assign a sense of pain and sacrifice to it.

Listening to Prof. Sarma speak on discipline is always very exciting; it just makes you look forward to embracing it. From his explanations, only one meaning resonates in my mind. That word is the most exciting word in any language and means a lot to everyone. In the true sense, discipline means freedom; discipline is freedom.



Standing on the terrace of their house, a man and his nine-year-old son were flying a kite. Looking at the kite high up in the sky the little boy remarked, "Dad, the kite can go still further up in the sky, but it is stuck there only because of the string. Before the boy could say anything else, the man suddenly took a blade and cut the string. Instantaneously, the kite came crashing down. The child was shocked. With a lot of assertiveness, the father looked in the eyes of his son and said, "No son, it is the other way round. It is only because of the string that the kite reached that height and was enjoying the freedom of the skies. Without the string, the kite cannot go up and stay there." That string is what I am referring to as discipline. It is our discipline that takes us to the top and helps us to stay there, enjoying all the rewards of being on top.

An hour of disciplined exercise gives us the freedom to enjoy good health and fitness in the remaining hours. At least half an hour of prayer regularly gives us peace of mind and a stress-free life. A disciplined time for the family means freedom from complaints and cribbing. A disciplined work schedule means freedom from pending and stressful work. Financial discipline means freedom from a cash flow crisis. Discipline = freedom.

I realized that for all the wrong and negative aspects, we have to pay a price, whereas for all the right and positive aspects of life there are only pay offs. But we still struggle to embrace what is good and right. Holding onto sadness, misery, crying, cribbing, hatred, revenge, jealousy, anger, dishonesty, and other wrong and negative aspects will only take away sleep, health, peace of mind and give heartaches, stress, hurt, cause excess secretion of acids and loss of relationship, and the list is endless. Whereas by holding on to right and good aspects like happiness, joy, laughter, forgiveness, love, inspiration and acceptance we only receive payoffs like good health, deep sleep, peace of mind, loving and harmonious relationships, bliss, enjoyment, fun etc.

Freedom is the not the right to do as we please, but the liberty to do what we ought to do. Rules are framed to make our freedom full and fair. Voluntary sacrifice of personal rights is the basis of peaceful social life. There is no liberty without limitations, no freedom without responsibility.

#WishingMostAndMore



Dr. M S Alphin



Dr. Satheesh Kumar G



Magari Ramasamy

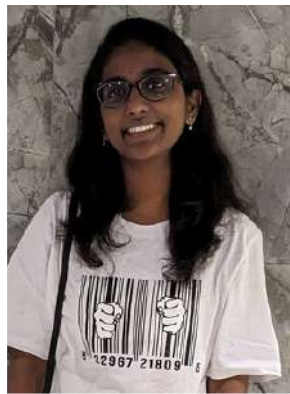

Abirami Subbaih



Aravindhan R



Nithish Kumar S



Dhivya Dharshini R



Mithun Kumar



Feedback to [aspire@mech.ssn.edu.in](mailto:aspire@mech.ssn.edu.in)