An aerial photograph of a modern, curved building with a green roof and lush landscaping. The building features a prominent, curved, light-colored facade that follows the curve of the roof. The roof is covered in dense greenery, including trees and shrubs. The building is surrounded by a well-maintained lawn and other green spaces. The overall scene is bright and vibrant, with a clear sky and lush greenery.

# EDIFIER

JULY 2023

VOL 8 ISSUE 1

THE NEWSLETTER OF THE  
DEPARTMENT OF CIVIL  
ENGINEERING

<b>S.No</b>	<b>CONTENTS</b>	<b>Pg. No</b>
<b>1</b>	<b>FROM HOD'S DESK</b>	<b>3</b>
<b>2</b>	<b>FACULTY ARTICLE</b>	<b>5</b>
<b>3</b>	<b>DEPARTMENT EVENTS</b>	<b>9</b>
	<b>3.1 INTERNATIONAL CONFERENCE (SPICE 2023)</b>	<b>9</b>
	<b>3.2 FACULTY DEVELOPMENT PROGRAMME (FDP)</b>	<b>10</b>
	<b>3.3 SEMINAR</b>	<b>11</b>
	<b>3.3.1 Steel and Composite Structures</b>	<b>11</b>
	<b>3.3.2 Constituent Assembly</b>	<b>12</b>
	<b>3.4 GUEST LECTURE Civil Laws</b>	<b>12</b>

	<b>3.5 WORKSHOP- One Day ONLINE WORKSHOP on Current Trends in Civil Engineering Research</b>	<b>12</b>
	<b>3.6 VALUE ADDED COURSE</b>	<b>14</b>
	<b>3.6.1 Safety in Construction</b>	<b>14</b>
<b>4</b>	<b>NOTABLE ACHEIVEMENTS</b>	<b>17</b>
<b>5</b>	<b>PLACEMENT ACTIVITIES (2022-2023)</b>	<b>19</b>
<b>6</b>	<b>ACTIVITY ROUNDUP – PROFESSIONAL SOCIETIES</b>	<b>20</b>
	<b>6.1 Association of Civil Engineers (ACE)</b>	<b>20</b>
	<b>6.2 Institution of Civil Engineers (ICE) UK</b>	<b>21</b>
	<b>6.3 Indian Concrete Institute (ICI)</b>	<b>23</b>
	<b>6.4 Institution of Engineers India (IEI)</b>	<b>28</b>
	<b>6.5 Indian Green Building Council (IGBC)</b>	<b>30</b>
<b>7</b>	<b>STUDY TOUR</b>	<b>33</b>
<b>8</b>	<b>PUBLICATIONS</b>	<b>35</b>

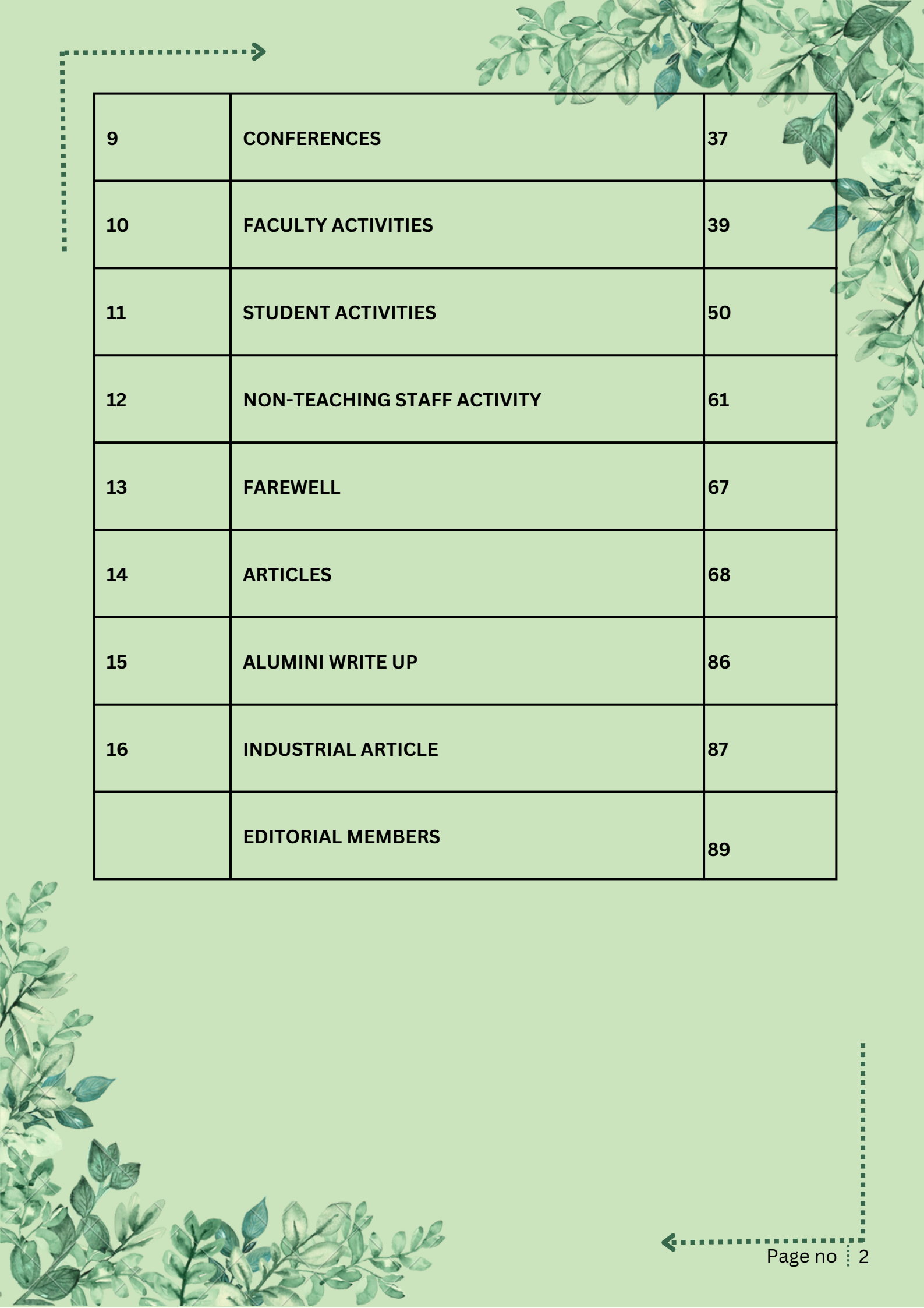

<b>9</b>	<b>CONFERENCES</b>	<b>37</b>
<b>10</b>	<b>FACULTY ACTIVITIES</b>	<b>39</b>
<b>11</b>	<b>STUDENT ACTIVITIES</b>	<b>50</b>
<b>12</b>	<b>NON-TEACHING STAFF ACTIVITY</b>	<b>61</b>
<b>13</b>	<b>FAREWELL</b>	<b>67</b>
<b>14</b>	<b>ARTICLES</b>	<b>68</b>
<b>15</b>	<b>ALUMINI WRITE UP</b>	<b>86</b>
<b>16</b>	<b>INDUSTRIAL ARTICLE</b>	<b>87</b>
	<b>EDITORIAL MEMBERS</b>	<b>89</b>

## 1. FROM HOD'S DESK



I am elated to bring to you the next edition of our Edifice, a bi-yearly Newsletter of Our Department of Civil Engineering, SSN Chennai. This phase of the edition marks completion of 2019-2023 batch as they move on to their next phase of their careers. Our motto and department's vision are to impart quality knowledge and industrial exposure to the students so that when they start their job on day one, our students will be prepared and trained for the industry's requirement.

Moreover, we have placed more than 90% of our department's placement registered students in both core and IT related industries through on campus placement system. This has been a major step up in our department's growth in placement statistics. This has been due to constant interaction with industrial experts and academicians who visit our campus and deliver expert talks through various student chapters. We organized an international conference titled, Sustainable Practices and Innovations in Civil Engineering (SPICE 2023) where researchers from various universities participated and presented their current research findings.

To mark the celebrations of world environment day where #Beat the Plastic was the focus area this year, our IGBC students organized a discussion session followed by campus plastic trash pickup. Our ICI student chapter conducted a one-day ICI FEST which was open to all engineering college students.

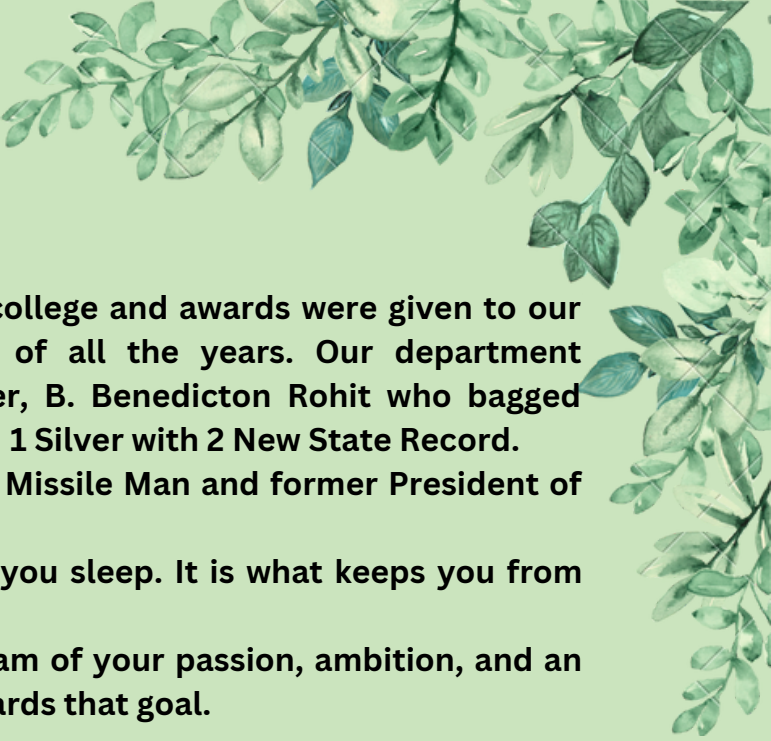

Institute day was conducted in our college and awards were given to our department's meritorious students of all the years. Our department celebrates our professional swimmer, B. Benedicton Rohit who bagged Tamil Nadu Senior States 4 Golds and 1 Silver with 2 New State Record.

I signoff with a famous quote by our Missile Man and former President of India, Dr. APJ Abdul Kalam.

“A dream is not what you see when you sleep. It is what keeps you from falling asleep.”

I urge all our students to have a dream of your passion, ambition, and an unhinged determination to work towards that goal.

- Dr.N. Sivakumar/Professor-  
HOD/Civil

## 2. FACULTY ARTICLE

**Construction-phase health and safety-  
Dr.R. Vijaya Lakshmi /Associate Professor**

In construction work, many of the hazards (a hazard is something with the potential to cause harm) are obvious. Most of them can be found on almost every site. The causes of accidents are well-known and often repeated. Too often hazards are just seen as an inevitable part of the job, so no action is taken to control the risks they create. Consequently, the rate of accidents and ill health remains high.



Action is needed to change this. The information in this section will help those carrying out risk assessments (by explaining how to identify hazards and select control measures. In finalizing an appropriate safe system of work for any construction job, it will be necessary to consider the particular nature of the site and the detail of the operations to be carried out.

### Site management and supervision

Effective management of work activities and competent site supervision is essential in maintaining healthy and safe conditions. The greater the risk, the greater the degree of control and supervision required. Ensure the level of site supervision provided is adequate. Site managers and supervisors should be trained to help them discharge their health and safety responsibilities.

## Working at height

Falls are the largest cause of accidental death in the construction industry. They account for 50% of all fatalities. There is no distinction between low and high falls. This means that for any work at height, precautions are required to prevent or minimize the risk of injury from a fall.

The hierarchy of control measures with practical examples:

**Avoid:** working at height unless it is essential (eg erect guard rails (Figure 1) on steelwork at ground level and then crane the steel and the guard rails into position; provide cast-in mesh across riser ducts at the position of services; fix nets using extending poles).

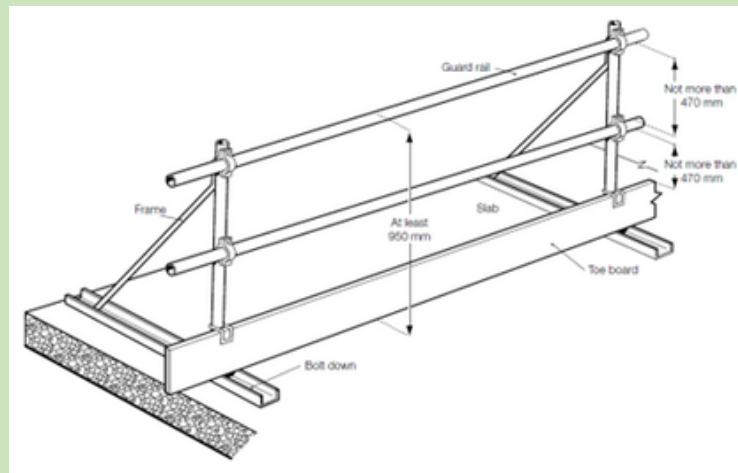

Figure 1 Guard Rails

Prevent falls by using an existing safe place of work that does not require the use or addition of work equipment to prevent a fall (eg a flat roof with permanent edge protection).

Prevent falls by using work equipment that protects all those at risk (eg access equipment fitted with guard rails, such as independent scaffolds, tower scaffolds (Figure 2), mobile elevating work platforms (Figure 3), and mast climbing work platforms (Figure 4).



Figure 2 Tower Scaffolding



Figure 3  
Mobile  
elevating  
working  
platform





**Figure 4 Mast climbing work platforms**

**Prevent falls by using work equipment that protects the individual (Figure 5) (eg a harness with a short lanyard that makes it impossible for a person to get to a fall position (this is called work restraint) or use a podium).**

**Mitigate falls by using work equipment to minimize the distance and consequences of a fall and protect all those at risk (eg nets or soft landing systems positioned close under the work surface (Figure 6)).**



**Figure 5 A work-restraint harness**



**Figure 6 Soft landing system**

**Mitigate falls by using work equipment to minimize the distance and consequences of a fall and protect the individual (eg a personal fall arrest system with the anchorage point sited above the head, or a rope access system).**

**Mitigate falls by using work equipment that minimizes the consequences of a fall (eg nets rigged at a lower level, or inflatable injury protection).**

**Mitigate: falls through training, instruction, or other means (eg ensure ladders are inspected regularly and are used by competent people, demarcate areas to provide**

a warning, provide adequate lighting, apply sensible housekeeping measures, provide suitable footwear, etc). The correct and incorrect posture of ladders is shown in Figure 6

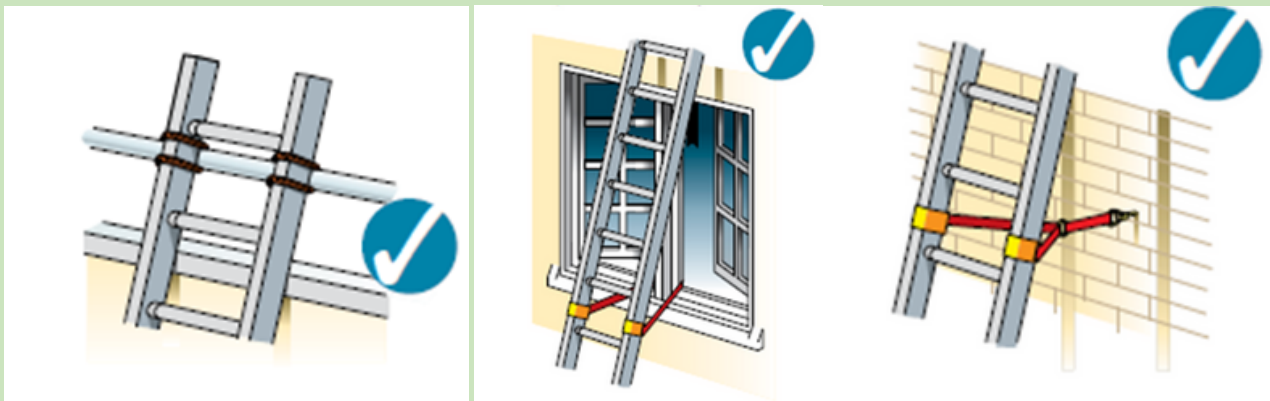
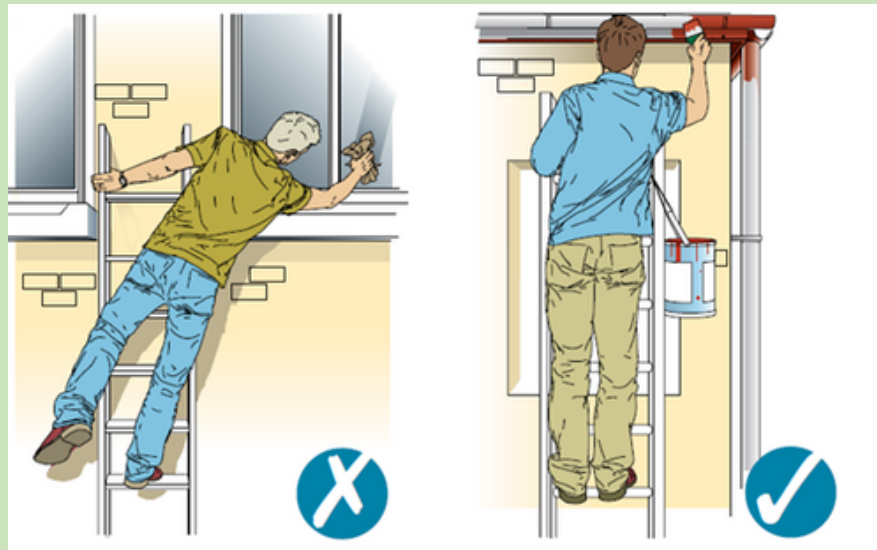

Figure 7 Some of the Correct and incorrect postures of the ladder

## Site traffic and mobile plant

Every year, workers are killed on construction sites by moving vehicles or by vehicles overturning. Many more are seriously injured in this way. The risks can be reduced if the use of vehicles and mobile plants is properly managed.

## 3 DEPARTMENT EVENTS

### 3.1 INTERNATIONAL CONFERENCE (SPICE 2023)

The 4th International Conference on Sustainable Practices and Innovations in Civil Engineering (SPICE 2023) was conducted by the Department of Civil Engineering on 23rd March 2023 to 24th March 2023 under the banner of IGBC, IIC, and ICI. The Conference Discuss Various Themes of Civil Engineering. The participants from various parts of the country participated and presented papers at the conference. The selected and reviewed paper will be published by Matec Web of Conferences. The Conference was funded by SSN Trust. Dr. Srinath Rajagopalan acted as Organizing chair and the conveners are Dr.Surendar Natarajan & Dr. Aswin Sriram G

The Notable Guest Speakers of the Conference are.

Dr. Rajasekhar Balasubramanian, Professor, NUS

Dr. Sriman Kumar Bhattacharyya, VC, SNUC

Dr. P.Vedagiri, Professor, IIT-Bombay, Mumbai

Dr. Venkata Reddy, Professor, NIT- Warangal



SPICE 2023 Inaugural Session

## 3.2 FACULTY DEVELOPMENT PROGRAMME (FDP)

A Faculty Development Programme on Structural Analysis II was organized by the Department of Civil Engineering between 30.01.2023 and 03.02.2023 by Dr. B. Mahalingam. The notable speakers of the FDP are from Industry and reputed educational institutions. One of the sessions in FDP was delivered by Mr. Balamourougane, Manager, Projects, TechApps Consulting Education on the topic 'Analysis of Plate Girders using STADD pro Connect on Wednesday 01.02.2023.



**Felicitation To the Guest Speaker**



**Participants Interactive Sessions**

## 3.3 SEMINAR

### 3.3.1 Steel and Composite Structures

A seminar on 'Steel and Composite Structures' on 21st February 2023 was organized by SSN-ICI Student Chapter. The seminar was organized by Faculty Coordinators, as Dr. S Ramanagopal and Dr. Sangeetha P. There were two sessions with notable speakers namely Dr. Rupen Goswami from IIT M and Dr. S. Vishnuvardhan from CSIR Chennai.

The first session was held in the morning with Dr. Rupen Goswami Professor, Dept of Civil Engineering, Indian Institute of Technology Madras, Chennai. He explained the need for the use of steel structures and properties of steel, their behavior under earthquake loading, quality of steel, and connections. The session was informative, and fun-filled. The afternoon session was delivered by



Session 1 by Dr. Rupen Goswami

Dr. S. Vishnuvardhan Principal Scientist, Fatigue and Fracture Laboratory, CSIR-Structural Engineering Research Centre, Chennai. He briefed me about the fracture and fatigue of steel along with a few formulas. He further presented the experiments that were conducted in the lab with videos. There were over 30 participants in the seminar, and they found it to be beneficial and effective.



Session 2 by Dr. S. Vishnuvardhan

### 3.3.2 CONSTITUENT ASSEMBLY

The Association of Civil Engineers organized a “SEMINAR” on 30th March 2023. The event started with the welcome of the speaker “ADVOCATE – R KANNAN (B.COM., B.L.)”. He is a distinguished advocate from the Tenkasi district, who has rich experience in handling Civil and Criminal cases at various district courts for the past 25 years.

He gave a moral lecture on the topic “CONSTITUENT ASSEMBLY”. He started his address by defining the meaning of the Constitution, which helps us in achieving a balance that which way we should go in life, which is not an easy thing. Everyone in India does not have equal opportunity to get merit. He also emphasized about Preamble and its importance, Constitution and its powers, the Parliaments and their roles, etc. The seminar was very informative and provided the students with enormous knowledge of various aspects of the Indian constitution.

ACE  
Association of Civil Engineers

SSN  
SRI SIVASUBRAMANIYA NADAR COLLEGE OF ENGINEERING  
(AN AUTONOMOUS INSTITUTION-AFFILIATED TO ANNA UNIVERSITY) KALAVAKKAM-CHENNAI

Department of civil engineering

**SEMINAR**

On 30th March, 2023  
1 pm - 3 pm  
@ Second year classroom

**SPEAKER :**

**R .KANNAN B.COM., B.L.,**  
Civil and Criminal  
Advocate(District Court)

**SOLELY FOR SECOND YEARS(COMPULSORY ATTENDANCE)**  
E-CERTIFICATES WILL BE PROVIDED

**FACULTY CO-ORDINATOR**  
Dr. S.V.Sivapriya

**CONVENOR**  
Dr.N.Sivakumar

## 3.4 GUEST LECTURE

### 3.4.1 Civil Laws

Mr. Duraipandi.D, Lawyer, High Court - Madurai visited our campus on 3rd May 2023. He delivered a guest lecture for the second-year students on Civil Laws as part of their mandatory course on the Indian Constitution.

## 3.5 WORKSHOP

**One-Day ONLINE WORKSHOP on Current Trends in Civil Engineering Research**

SSN – ICI Student Chapter organized a ‘One-day online workshop on Current Trends in Civil Engineering Research’ on 15th February 2023 organized by SSN-ICI Student Chapter, Faculty Coordinator, Dr. Sangeetha P, and Dr. Jijo James. There were three sessions with key speakers namely Dr. Ramachandra Murthy, Dr. Pijush Samui, and Dr. N Sivakumar.

The session was delivered by Dr. Pijush Samui, Professor, Department of Civil Engineering, NIT Patna. He briefed us about the future trends and he further gave us a glimpse into the procedure for publishing a research paper. The third session was presented by Dr. N Sivakumar, Professor and Head of the Department, Department of Civil Engineering, SSN College of Engineering – Chennai. Dr. N Sivakumar explained various emerging trends in Civil Engineering.

The participants found the session to be highly knowledgeable and thought-provoking. The session was interactive and benefitted over 30 participants.

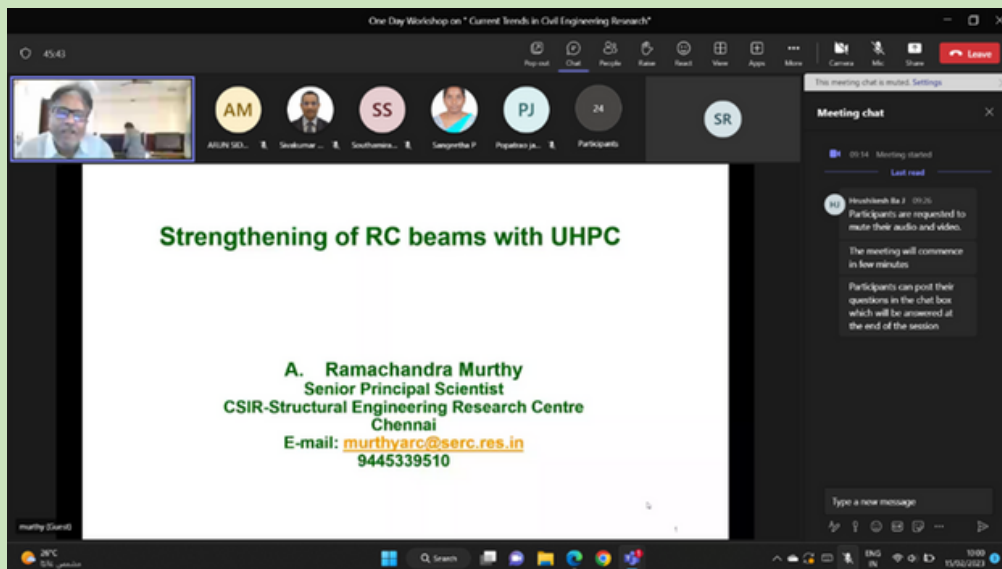

Session 1 by Dr. Ramachandra Murthy

The first session was held with Dr. Ramachandra Murthy Senior Principal Scientist, Structural Engineering Research Centre (SERC), Chennai as the key speaker. Dr. Ramachandra Murthy briefly explained RC beams with UHPC. He also mentioned their advantages, their application, and the scope of the material. Students were educated about this material briefly on various aspects. The second session was about Future Trends in Civil Engineering in the field of Geotechnical Engineering.



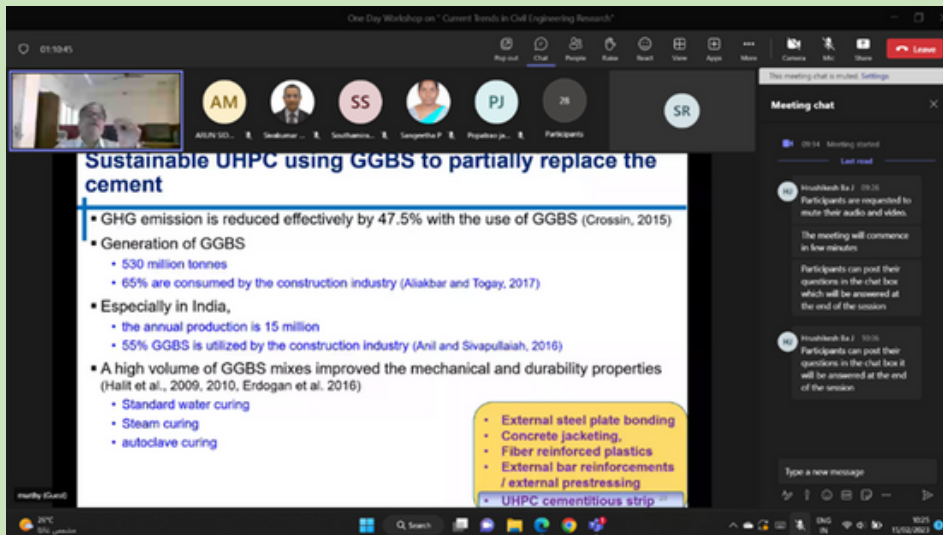

Session 2 by Dr. Pijush Samui

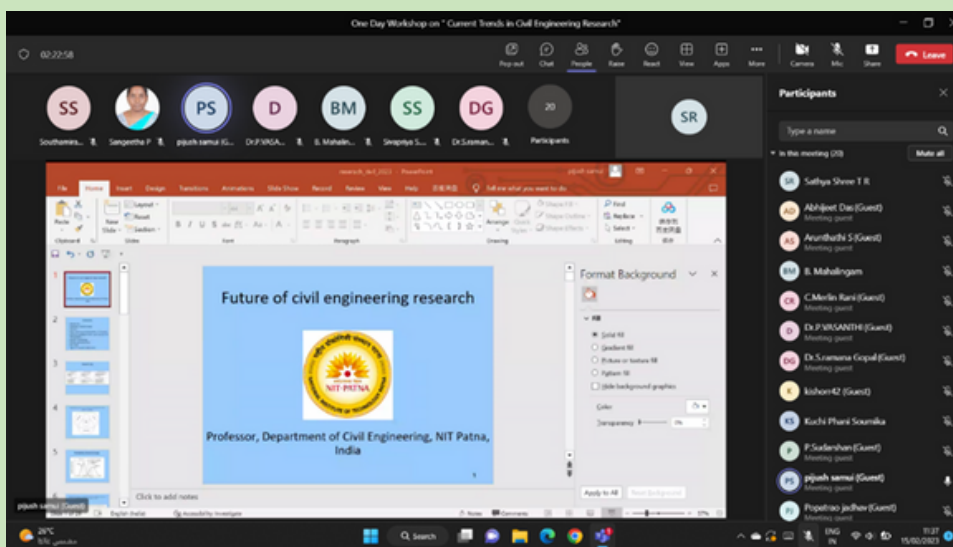

Session 2 by Dr. Ramachandra Murthy

## 3.6 VALUE ADDE COURSE

### 3.6.1 Safety in Construction

The construction industry employing the largest labor force in the country has accounted for about 11% of all occupational injuries and 20% of all deaths resulting from occupational accidents. Most of the accidents that take place are due to a lack of knowledge and skill of the workers and the supervisors. To make the students aware of the present scenario in construction safety, accidents cause and preventive measures and laws related to safety aspects, a value-added course on the SAFETY IN CONSTRUCTION was planned during AY 2022-23 - odd semester. The course was offered to second-year civil students to have a general idea about construction safety. Academic Experts from IIT and safety managers

and site engineers from different construction industries addressed our students and shared their practical knowledge. Dr. Nikhil Bugalia AP, IIT-Madras, handled introduction to safety in construction and accident and incident investigation. He sparked the students' interest in the safety program and wrapped up his presentation with a discussion of health issues in construction.

After an academic speaker, Mr. Sai Prasad, an industrial specialist from NKT operations India Pvt Ltd, spoke to the students on personal protective equipment, shared his professional insight with a case study, and then closed the session with a discussion on fatal falls. Mr. Deena Dhayalan from L&T Bangalore gave an online lecture on crane safety and fire and electrical safety and shared his experience in the Bangalore construction site. Mr. Dhilip Venkatachalam from Saipem India projects Ltd shared his experience on the general safety aspects followed in the chemical industry. A few sessions were handled by Dr. R. Vijayalakshmi, ASP, SSN College of Engineering. Er. Ema, a BIM Consultant and trainer, concluded the value-added course. She imparted her expertise on BIM modeling and its significance for construction safety. Table 1 contains information about the session and the expert. Below are a few photos from the value-added course session.

**List of Topics – Value Added Course**

Sessions	TOPICS	Speakers	Session date
<b>Session: 1</b>	Introduction to safety in construction	Dr. Nikhil Bugalia - (Assistant professor- IIT Madras)	04/01/23 (FN) 10 am -11 am
<b>Session: 2</b>	Introduction to safety standards, signs, and signals in construction	Dr. Nikhil Bugalia - (Assistant professor- IIT Madras)	04/01/23 (FN) 10 am -11 am
<b>Session: 3</b>	Safety program accident/Incident investigation	Dr. Nikhil Bugalia - (Assistant professor- IIT Madras)	05/01/23 (FN) 11 am -12 Noon
<b>Session: 4</b>	Personal protection Equipment in construction	Dr. Sai prasad- NKT operations India Pvt. limited	06/01/23 (FN) 10:00 am - 10:45 am
<b>Session: 5</b>	A case study in construction safety	Mr. Sai prasad- NKT operations India Pvt. limited	06/01/23 (FN) 10:45 am - 11:30 am
<b>Session: 6</b>	Introduction to fatal falls	Mr. Sai prasad- NKT operations India Pvt. limited	06/01/23 (FN) 11:30 am - 12:30 pm

Session: 7	Fall hazards in concreting	Dr. R. Vijayalakshmi, ASP, Civil, Sri Sivasubramaniya Nadar College of Engineering	23/01/23 (online)
Session: 8	Fall hazards in demolition work	Dr. R. Vijayalakshmi, ASP, Civil, Sri Sivasubramaniya Nadar College of Engineering	24/01/23 (online)
Session: 9	Trench and tunnel safety	Dr. R. Vijayalakshmi, ASP, Civil, Sri Sivasubramaniya Nadar College of Engineering	25/01/23 (online)
Session: 10	Crane Safety	Mr. Dheena dhayalan (L & T Bangalore)	05/01/23 (Online) 5:00 pm -6:00 pm
Session: 11	Fire and electrical safety, safety in steel construction	Mr. Dheena dhayalan (L & T Bangalore)	05/01/23 (Online) 5:00 pm -6:00 pm
Session: 12	Health issues in construction	Mr. Nikhil Bugalia - (Assistant professor- IIT Madras)	05/01/23 (AN) 1:00 pm -2:00 pm
Session: 13	General safety precautions	Mr. Dhilip Venkatachalam (Saipem India projects limited- Chennai)	07/01/23 (Online) 5: 00 pm -6:00 pm
Session: 14	Managing hazards in construction	Dr. R. Vijayalakshmi, ASP, Civil, Sri Sivasubramaniya Nadar College of Engineering	25/01/23 (online)
Session: 15	BIM for safety in construction	EMA BIM consultant	09/01/23 (online)



**Sessions Of Value Adde Course – Safety In Construction**





**Sessions Of Value Adde Course – Safety In Construction**

#### **4. NOTABLE ACHIEVEMENTS**

**Mr. B Benedicton Rohit, a second-year student from the Department of Civil Engineering, has secured three gold and five silver medals in the Khelo India University Games swimming competitions held at Noida from 26th May to 29th May organized by the Government of India.**





**B.Benedicton Rohit (II yr / CIVIL ) has secured 4 Golds and 1 Silver with 2 New State Records**



## 5. PLACEMENT ACTIVITIES (2022-2023)

The placements in AY2022-2023 for the 2019-2023 batch have neared completion in our Department of Civil Engineering. Our Department of Civil Engineering can proudly announce now that we have successfully placed 39 students out of 49 registered students, roughly 80% effective placement for the 2019-2023 batch. Similarly, 42 out of 53 registered students have received offers in the 2018-2022 batch. The students have equipped and prepared themselves for the interview procedures and protocols with help from CDC and alumni engagement with seniors, leading to good placements. The entire credit for reaching this milestone resides with our pupils, who have persevered through all obstacles with unwavering effort and forward motion. This effort and perseverance in recruiting core civil engineering organizations for placements demonstrate the passion our Head of Department has for boosting placements. Notable companies L&T, Technip, Woods, Shell, First Solar, and Srinsoft were the core companies to take our students. Apart from placements, our 2018-22 students have also secured admissions from prestigious overseas universities like Loughborough University, Chalmers University of Technology – Sweden, University of Liverpool, Sheridan College Institute of Technology, Ryerson University Canada, UC Davis, and Purdue University United States for the Master's Program in Civil Engineering. Similarly, two students from the 2019-23 Batch have secured Graduate admission to Newyork University and Adelaide University. We wish all the students a bright future ahead in their life.

**Dr. Aswin Sriram G.**  
**Faculty Placement Coordinator - Civil**



## 6. ACTIVITY ROUNDUP – PROFESSIONAL SOCIETIES

### 6.1 Association of Civil Engineers (ACE)

The society of ACE in the civil engineering department organizes various events in the department like connexions to learn about new terminologies. It also involves conducting department symposium instinct. To make students feel free fun activities like chit Chat sessions are also conducted. A group of student members and one faculty advisor are involved.

#### A) Connexions

The Association of Civil Engineers organized a game event “CONNEXIONS” on 29th January 2023. The event started with the welcome of participants and the rules were explained. The purpose of this game is to learn new terminologies and to provide a minuscule amount of entertainment. Five teams participated with 2-3 members in a team. 25 terminologies and technical words related to Civil Engineering were chosen. Participants should guess the word from the illustrated images. Exactly, 20 seconds were assigned for each word. The participants were very active and enthusiastic. Team A2 – is the winner of the game that guessed a greater number of the words. Every participant including winners had received attractive E-certificates.

#### B) Chit-Chat Session

Association of Civil Engineers organized a chit-chat session with one of our Alumni Mr. Prabhakaran P on 23rd February 2023. He is from the 2018 – 2022 batch. He is currently working as a Data Analyst at Latent view Analytics Ltd. The session started with the welcome address followed by the alumni interaction. The speaker started with the placement data of his batchmates. Then proceeded with sharing his preparation strategy for the placements. He also shared his experience in different interviews. He then elaborated on Data Science and the role of a Data Analyst. Finally, he concluded with some tips to maintain a balance between placements and academics. The session concluded with a vote of thanks. The participants found the session to be interactive and enlightening.



## 6.2 Institution Of Civil Engineers (ICE) UK

The ICE(UK) SSN Student chapter engages in a variety of activities to enhance knowledge and promote networking. **Webinars:** We regularly organize informative webinars featuring industry experts, covering a range of topics related to civil engineering. These webinars provide valuable insights and updates to students. **Workshops:** We host workshops that focus on developing practical skills relevant to civil engineering. These hands-on sessions allow students to gain practical experience and enhance their understanding of key concepts. **Site visits:** To provide a real-world perspective, we organize site visits to ongoing construction projects. These visits offer students a chance to witness the implementation of engineering principles in practice. **Competitions:** We arrange competitive events that challenge students to apply their engineering knowledge in innovative ways. These competitions foster creativity and teamwork while encouraging students to think beyond the classroom.

### A) Workshop Report: Introduction to ACCA Software and BIM Authoring Solutions

The ICE(UK) SSN Student Chapter organized a two-day workshop on the 13th and 14th of March 2023, titled "Introduction to ACCA Software and BIM Authoring Solutions." The workshop aimed to familiarize students with the latest software tools in the field, including Edificius and BIM 5.

The event commenced with an engaging introduction to ACCA Software and its relevance in the architecture and construction industry. Participants gained insights into the features and capabilities of Edificius, a cutting-edge software solution for architectural design. Additionally, they explored BIM 5, a powerful BIM authoring tool, and its role in streamlining construction processes.

The workshop fostered an interactive learning environment, allowing students to grasp key concepts and develop practical skills.

Overall, the "Introduction to ACCA Software and BIM Authoring Solutions" workshop provided an excellent platform for students to acquaint themselves with the latest software tools, enabling them to stay at the forefront of the industry.



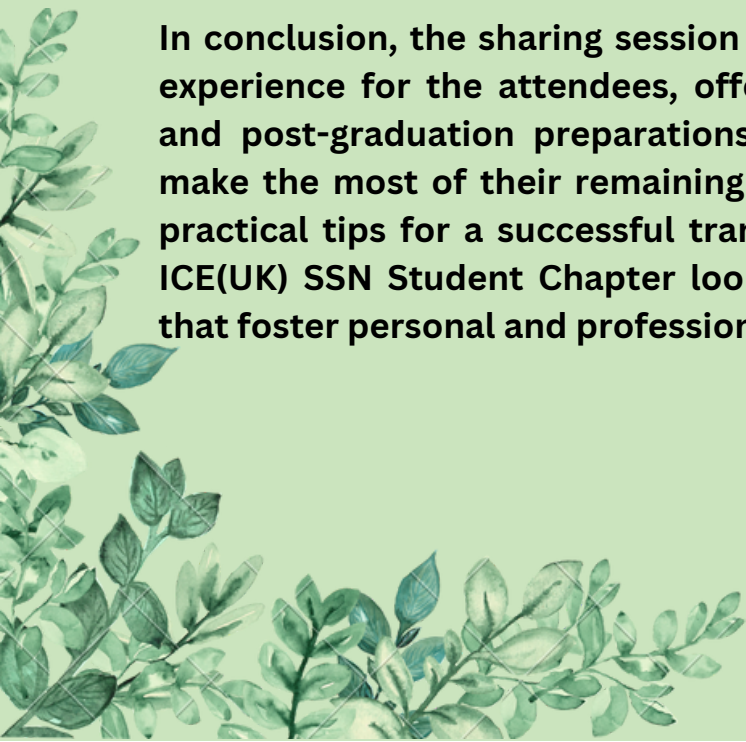
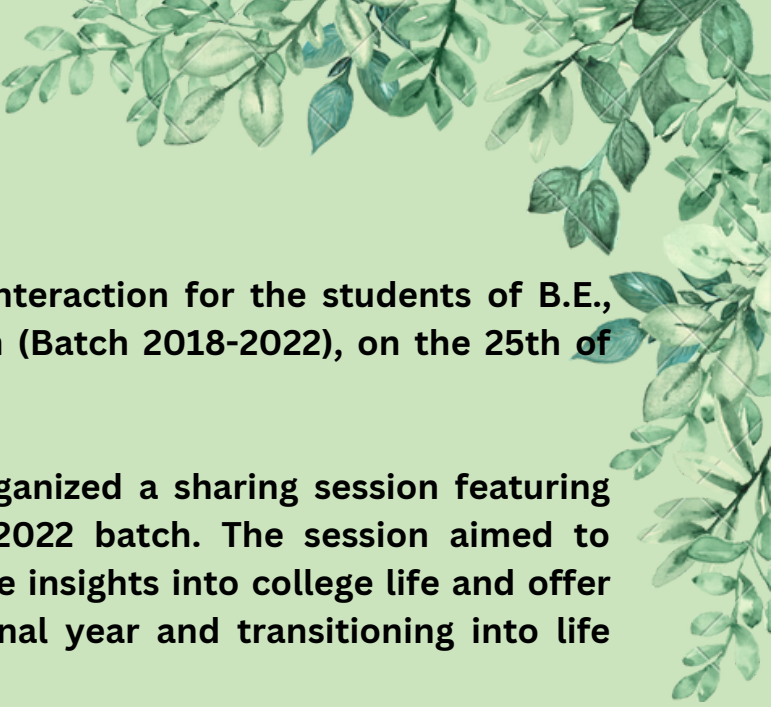

## B) Sharing Session

Dr. Jijo James organized an alumni interaction for the students of B.E., Civil Engineering with Mr. P.G. Vikram (Batch 2018-2022), on the 25th of February 2022.

The ICE(UK) SSN Student Chapter organized a sharing session featuring Vikram, an alumnus from the 2018-2022 batch. The session aimed to provide current students with valuable insights into college life and offer guidance on navigating the crucial final year and transitioning into life after college.

Vikram commenced the session by sharing his personal experiences and reflections on his college journey. He discussed the importance of making the most of the college years, emphasizing the significance of striking a balance between academics and extracurricular activities. Vikram highlighted the value of building networks, participating in events, and engaging in collaborative projects to enhance overall growth and development.

As the discussion shifted to the final year of college, Vikram outlined key areas that students should focus on during this critical period. He emphasized the importance of setting clear goals, managing time effectively, and prioritizing academic projects and assignments. He also encouraged students to leverage the resources available within the college, such as faculty guidance and career services, to maximize their learning opportunities and prepare for the future.

In conclusion, the sharing session featuring Vikram provided an enriching experience for the attendees, offering valuable insights into college life and post-graduation preparations. The session empowered students to make the most of their remaining college years and equipped them with practical tips for a successful transition into the professional world. The ICE(UK) SSN Student Chapter looks forward to organizing similar events that foster personal and professional growth among its members.

## 6.3 Indian Concrete Institute (ICI)

The ICI Student chapter engages in organizing seminars, guest lectures, and site visits. This time we conducted one day workshop on Current Trends in Civil Engineering Research. The chit-chat sessions between juniors and seniors were organized. The ICI fest was conducted for the knowledge-sharing process among peer groups.

### A) Chit – Chat Session

SSN – ICI Student Chapter organized a Chit Chat session with Vaishnavi M, an alumna of batch 2021, who is currently working in Cognizant as a Programme Analyst. The session was mainly focused on 3rd-year students of the 2022 – 23 batch who are about to face their placement season in a few months. Participants cleared their doubts regarding the placement process, they asked questions on how to balance work life. How was the experience on the domain switch? Etc.

There were over 40 participants who interacted with the speaker, clearing their doubts. They found the session to be informative.



Chit Chat Session

### 6.3 Indian Concrete Institute (ICI)

The ICI Student chapter engages in organizing seminars, guest lectures, and site visits. This time we conducted one day workshop on Current Trends in Civil Engineering Research. The chit-chat sessions between juniors and seniors were organized. The ICI fest was conducted for the knowledge-sharing process among peer groups.

#### A) Chit – Chat Session

SSN – ICI Student Chapter organized a Chit Chat session with Vaishnavi M, an alumna of batch 2021, who is currently working in Cognizant as a Programme Analyst. The session was mainly focused on 3rd-year students of the 2022 – 23 batch who are about to face their placement season in a few months. Participants cleared their doubts regarding the placement process, they asked questions on how to balance work life. How was the experience on the domain switch? Etc.

There were over 40 participants who interacted with the speaker, clearing their doubts. They found the session to be informative.



Chit Chat Session



## **B) ICI Tech Fest**

**SSN – ICI TECH FEST, an intercollege event was organized by the SSN ICI student’s chapter on 25th April 2023 coordinated by Dr. Sangeetha P and Dr. N. Sivakumar. The Tech Fest comprised four events namely quiz, treasure hunt, paper presentation, and connections. Students from across Tamil Nadu participated in the event.**

**The first half of the fest had a Paper presentation and quiz happening simultaneously. The paper presentation was judged by Dr. P. Sangeetha where students presented their findings. Dhinesh, Shyam Sundar S, and Thayumanavar from Sastra University, Thanjavur banged the first place. The Quiz comprised 6 teams with 3 members per team. Abhinaya D, Mahlakshmi G and Atchaya K won the First place.**

**The second half of the fest had a treasure hunt and connections taking place simultaneously. General instructions for the teams were given for treasure hunt and the race began, the first to collect all the hints and the final answer were announced as the winner. S. Srinidhi, S. Kranisha, M. N. Nishta, R. Sai akshara secured first place. Connections also had preliminary round hosting 12 teams and the first 5 teams were shortlisted for the final round. Ashwin Kumar KT, Atchayah K, Mahalakshmi G won the first place.**

**The SSN ICI Tech Fest valedictory function was presided over by Dr. N. Sivakumar, HOD of Civil Department, SSN College of Engineering. There were over 30 participants participating in different events, refreshing and gaining knowledge in the basic concepts. The participants found the event to be knowledgeable and entertaining.**



**Treasure Hunt (Chamber of Secrets)**



**Quiz (Code Wizard)**



### **Paper Presentation**

**DR. P. Sangeetha organized an Alumni interaction for rural students on the 28th of January 2023 under the ICI Student Chapter.**

**Dr. P.Sangeetha has organized a Chit - Chat Session for the students of II and III Year on 01/04/2023 by Ms. M. Vaishnavi (Alumni Batch 2018-2022), Programme Analyst, Cognizant Technology Solutions Pvt. Ltd, under the banner of ICI Student Chapter of SSN College of Engineering.**

## 6.4 Institution Of Engineers India (IEI)

The IEI professional activities engages in organizing seminar, guest lecture and national level competitions. This time we had conducted two-day workshop on BIM. The national level poster presentation competition was conducted. The participants from various colleges across national level has participated in poster competitions. For best poster design awards were given.

### A) Two-Day Workshop

The student chapter organized a Two-day workshop from February 13th 2023, to February 14th 2023. The presenter was Mr. Bala Sakthivel, BIM Modeler & Trainer, Walflower Designs and Engineers. The Workshop helped students understand “basics of Revit and its application.”

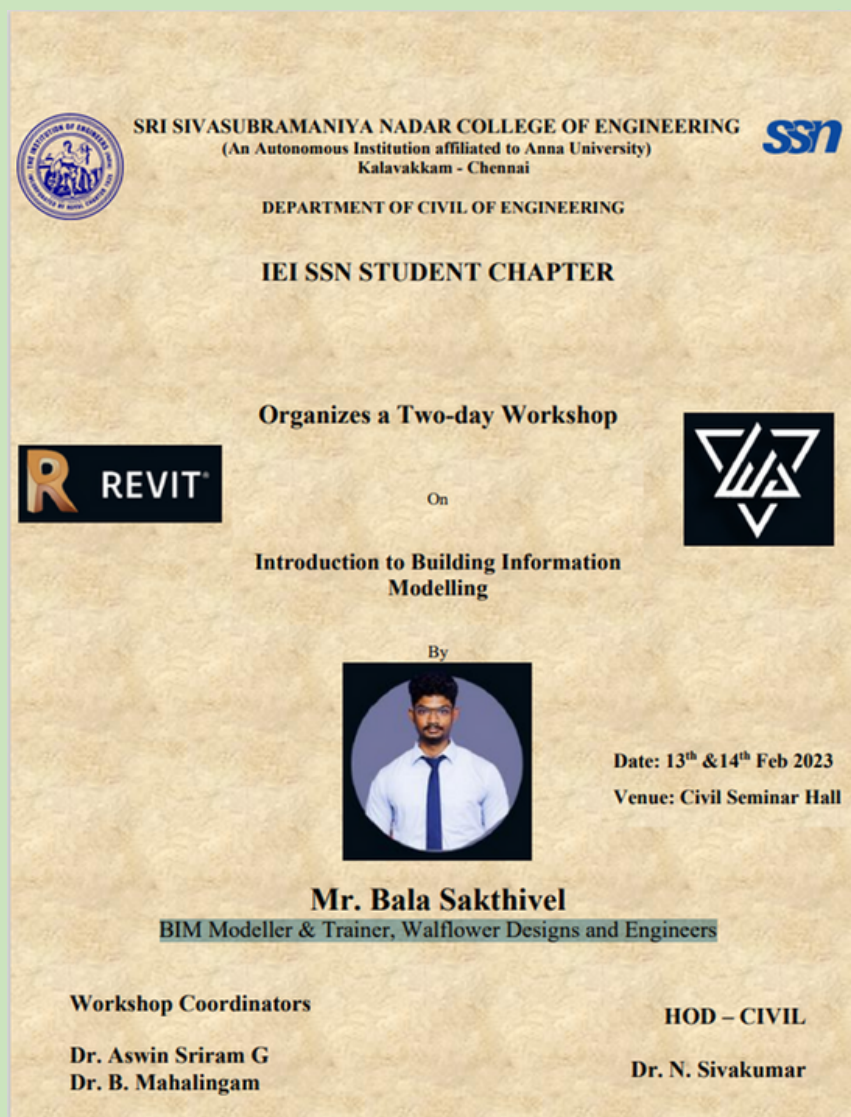

The poster is for a two-day workshop organized by the IEI SSN Student Chapter at Sri Sivasubramaniya Nadar College of Engineering. It features the college's logo, the SSN logo, and the Revit logo. The workshop is titled 'Introduction to Building Information Modelling' and is presented by Mr. Bala Sakthivel, a BIM Modeler & Trainer at Walflower Designs and Engineers. The dates are February 13th and 14th, 2023, and the venue is the Civil Seminar Hall. Workshop coordinators are Dr. Aswin Sriram G and Dr. B. Mahalingam, and the HOD-Civil is Dr. N. Sivakumar.

 **SRI SIVASUBRAMANIYA NADAR COLLEGE OF ENGINEERING**  
(An Autonomous Institution affiliated to Anna University)  
Kalavakkam - Chennai

 **ssn**

DEPARTMENT OF CIVIL OF ENGINEERING

IEI SSN STUDENT CHAPTER

Organizes a Two-day Workshop

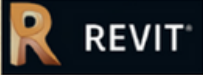
 **REVIT**

On



Introduction to Building Information Modelling

By



Date: 13<sup>th</sup> & 14<sup>th</sup> Feb 2023  
Venue: Civil Seminar Hall

**Mr. Bala Sakthivel**  
BIM Modeller & Trainer, Walflower Designs and Engineers

Workshop Coordinators

Dr. Aswin Sriram G  
Dr. B. Mahalingam

HOD – CIVIL  
Dr. N. Sivakumar

## B) National Poster Competition

The student chapter organized a national poster competition on February 15th, 2023, where students from different colleges were allowed to participate and create posters on the topic “Recent Advances in Civil Engineering in India”. It was an online competition where students mailed their work and top three were awarded cash prizes.



**SRI SIVASUBRAMANIYA NADAR COLLEGE OF ENGINEERING**  
(An Autonomous Institution affiliated to Anna University)  
Kalavakkam - Chennai



DEPARTMENT OF CIVIL OF ENGINEERING

**IEI SSN STUDENT CHAPTER**

Invites your participation for

**National Level Online Poster Presentation Competition**

On

**Recent Advances in Civil Engineering in India**

**Eligible participants:** UG Civil Engineering Students from UGC-AICTE approved colleges & Universities.

**Poster Guidelines:**

1. Only one entry per Participant and a maximum of three participants per poster.
2. Only Soft Copy of the Poster is required for the competition.
3. The poster must be in PDF format without any pixel damage.
4. The poster must be strictly restricted to one page – Portrait Orientation (A2 Size).
5. The poster must contain the following essential details:
  - a. Name of the student and the College of studying.
  - b. Title and Objective of the poster
  - c. Methodology
  - d. Critical outputs from the study
  - e. Figures and Tables substantiating the study.
  - f. Conclusions and Future scope

**First prize: Rs.2500**  
**Second Prize: Rs.1500**  
**Third Prize: Rs.1000**

**Posters (in PDF) should be mailed to: [aswinsriramg@ssn.edu.in](mailto:aswinsriramg@ssn.edu.in)**

**Last Date: 15.03.2023**

**Coordinators**

**Dr. Aswin Sriram G**  
**Dr. B. Mahalingam**

**HOD – CIVIL**

**Dr. N. Sivakumar**

For any queries: Please mail us at [aswinsriramg@ssn.edu.in](mailto:aswinsriramg@ssn.edu.in)



## 6.5 Indian Green Building Council (IGBC)

IGBC (Indian Green Building Council) green home is the first rating program developed exclusively for residential properties in India. This rating program is a medium through which designers can apply green concepts and principles to reduce the environmental impact of constructing new buildings. The IGBC is active professional body in the Civil Engineering department. This year an International conference SPICE 2023 is conducted under IGBC banner.

### A) Introduction to IGBC New building rating system

The IGBC Student chapter organized a seminar on Topic “Introduction to IGBC New building rating system” on 7th February, 2023. The presenter was Head of the Department of Civil Engineering, SSN college of Engineering. Dr. N.Sivakumar. The presenter gave a brief introduction about IGBC rating system and inspired many students become IGBC AP member. He also briefly explained about the qualities of a green building.



SRI SIVASUBRAMANIYA NADAR COLLEGE OF ENGINEERING  
(AN AUTONOMOUS INSTITUTION - AFFILIATED TO ANNA UNIVERSITY) KALAVAKKAM - CHENNAI

INDIAN GREEN BUILDING COUNCIL (IGBC)  
DEPARTMENT OF CIVIL ENGINEERING  
SSN-IGBC STUDENT CHAPTER

SSN IGBC CORDIALLY INVITES YOU FOR THE SEMINAR ON

**“INTRODUCTION TO IGBC GREEN  
NEW BUILDINGS RATING SYSTEM”**



**Dr. N. Sivakumar**  
H.O.D Civil Department , SSN College of Engineering  
On 7<sup>th</sup> February 2022, Friday 8:50 AM – 9:40 AM  
VENUE : Third year classroom (CELH 02)

Dr. R .Srinath  
CO-ORDINATOR

Dr. N SIVAKUMAR  
CONVENOR

For any query, contact Student Co-ordinators – Ashwin kumar / 7601871999  
– C.Adarsh / 6379006209

## B) How to engineer an entrepreneur out of you?

The IGBC student chapter organized a webinar on “How to engineer an entrepreneur out of you” on 30th March 2023. The presenter was Vice president of Perfect Steel, Lumberton, USA. The presenter gave a brief introduction about starting a firm in core engineering and the presenter also shared his experience in life, which motivated the students to enter to entrepreneurship. In the end the presenter detailly answered the queries of the participants.



SRI SIVASUBRAMANIYA NADAR COLLEGE OF ENGINEERING  
(AN AUTONOMOUS INSTITUTION - AFFILIATED TO ANNA UNIVERSITY) KALAVAKKAM - CHENNAI ,INDIA

INDIAN GREEN BUILDING COUNCIL (IGBC)  
DEPARTMENT OF CIVIL ENGINEERING  
SSN-IGBC and SSN-ICI STUDENT CHAPTERS  
SSN IGBC and SSN-ICI in association with SSN-Institution's  
Innovation Council (SSN-IIC 5.0)  
CORDIALLY INVITES YOU FOR THE EXPERT TALK ON

**“HOW TO ENGINEER AN ENTREPRENEUR  
OUT OF YOU”  
SPEAKER**



**Dr.Kannan Nagarajan**  
Vice President - Operations at Perfect Steel  
Lumberton, Mississippi, USA

Registration form : <https://forms.gle/YvBgEAv7uW7ag3Yb6>

On 30<sup>th</sup> March 2023, Thursday 2:30 PM– 3:30 PM IST

Dr. R .Srinath  
CO-ORDINATOR

Dr. N SIVAKUMAR  
CONVENOR

For any query, contact Student Co-ordinatorS - Ashwin kumar /7601871999  
- C.Adarsh / 6379006209

## C) Sustainable Practices Innovation in Civil Engineering (SPICE) 2023

The IGBC professional society organized one of the Department's Prestigious Conference SPICE 2023. Chief guests were invited from various fields in Civil engineering at National & International level who had immense research knowledge in their field. The presenters of the conference were from various Institution. The Volunteers and office bearers of IBGC gave their full potential to make the Conference a great success.



**SRI SIVASUBRAMANIYA NADAR COLLEGE OF ENGINEERING**  
(AN AUTONOMOUS INSTITUTION - AFFILIATED TO ANNA UNIVERSITY)  
Rajiv Gandhi Salai, Kalavakkam - 603 110

**Department of Civil Engineering**  
cordially invites you to the inauguration of the  
**4<sup>th</sup> International Conference on Sustainable Practices and Innovations in Civil Engineering (SPICE 2023)**  
on  
**March 23<sup>rd</sup> 2023, Thursday**  
Venue: Mini Auditorium



**Chief Guest**  
**Dr. Rajasekhar Balasubramanian**  
Professor  
Deputy Head (Communication & Engagement),  
Dept of Civil and Env. Engg,  
National University of Singapore



**Principal**  
**Dr. Ve. Annamalai**  
SSN College of Engineering



**Vice - Principal**  
**Dr. S Radha**  
SSN College of Engineering



**Conference Chair**  
**Dr. N Sivakumar**  
Prof & Head  
Department of Civil Engineering, SSNCE

## D) World Environment Day

World Environment Day Celebrations were done on 5th June 2023. The Students Presented topic on Microplastic Impact on Environment. Interactive sessions were held between Faculty and Students for Better Sustainability of Environment.



Participation Of Student Members- World Environment Day

## 7. STUDY TOUR

### 7.1 Site Visits

A) Dr. P. Sangeetha organized a site visit to "RMC Plant, Guduvancheri" on "11th Jan 2023" for "II Year Civil Engineering students" under the banner of "ICI Student Chapter."

B) A site visit for the second-year students of B.E. Civil Engineering to the construction site of the Law School of Shiv Nadar University, Chennai was organized on the 18th of April 2023 by Dr. S. V. Siva Priya. The students were able to see the various stages of construction of a framed structure including masonry walls and roof slabs. They also got to know the various safety precautions followed at site during construction.



**Second-Year Students of B.E. Civil Engineering- Site Visit at Law School of Shiv Nadar University, Chennai**

### **C) Kondangi Lake Site Visit**

**On 10th May 2023 (Wednesday), we went to a lake called Kondangi located on the way from thiruporur to Chengalpattu for a site visit. The site visit was arranged by Dr Surendar Natrajan and accompanied by Dr. R.Vijaya lakshmi. Thiru Baskar P.W.D., W.R.O., officer came to the site for give a briefing about the lake.**

## HISTORY OF LAKE:

The P.W.D., officer explained about the history of the lake first. The lake was built and maintained by pallavas. They build two temples across the bank of lake. There is a belief that if we gave a sacrifice of cattle to the god, then the rain won't cause any damage to life and property of humans.

## About Lake:

The total area of the lake is 472 hectares which is equal to  $472 \times 2.74 = 1293.28$  acres. This is a special lake because there is a sluice along with kadingal. The rise of kadingal from mean sea level is 33.306m. This lake comes under non system tank, where water will stored and supply water without a proper channel. The lake will be in a crescent moon shape. The lake has three agricultural canals. Each canal is separated by 400m. There is a tank for energy dissipation and to prevent hydraulic jump from a height of 30-35 cm. The maximum depth seen in this lake is 16 feet at the number 1 canal.

## Tank cascade:

The general lake's tank cascade will be

1. River. 2. Reservoir. 3. Lake. 4. Ethal. 5. Thangal. 6. Pond. 7. Kuttai. 8. Well.

The tank cascade of kondangi lake is

Maruderi → Maruderi thangal → Kondangi lake → Manamathi → Kotamedu → Backingham Dam.



Kondangi Lake



Civil Engineering Students (2021-2025)

## 8. PUBLICATIONS

M. Abhinaya, R. Parthiban, N. Sivakumar, (2022), Effects of using palm flower biochar in mechanical and water purification properties of pervious concrete. Biomass Conversion and Biorefinery. <https://doi.org/10.1007/s13399-022-03606-7>. Springer (wos).

A. Syamsir; A. R. Malekzadah; S. Naganathan; Z. Itam; N. M. Nor; M. Chair; R. Imani, (2023), "Comparative study on the effect of rhombus and rectangular openings of shear wall on the behavior of tall buildings", AIP Conference proceedings, 2544, 040001 (2023), April 24, 2023. (Scopus). <https://doi.org/10.1063/5.0116729>

Vijayalakshmi.R., (2022), "Study on the performance of GFRP strengthened fiber reinforced lightweight foam concrete", Building Materials and Structures, Vol 64(4), pp. 137-148, (2217-8139), doi: 10.5937/GRMK2204137R.

Vijayalakshmi, R., Mohammed,Sameer., and Geetha,R., (2022), "Comparative study on the performance of caryota urens fiber reinforced concrete of different grades along with Digital image processing techniques", Revista Iteckne, vol.19,no.2, Jun.2022.DOI: <https://doi.org/10.15332/iteckne.v19i2.2827>, ISSN: 2339-3483.

Vijayalakshmi, R., Yogesh, B., Prashant, S., Nitish Kanna, K., and Thosi, G., (2023), " Influence of biomass ash and coconut shell in scrap steel fiber reinforced concrete", Building Materials and Structures, Vol 66, no. 1, March 2023, pp. 25-41, DOI: 10.5937/GRMK2301001N, ISSN: 2335-0229.

Vijayalakshmi, R (2022) The Compressive Strength Of Confined Concrete Stub Column Reinforced With GFRP Bars- Effect Of Reinforcement Ration And Bar Diameter. Recent advance in Materials Technologies, Lecture Notes in Mechanical Engineering. [http://dx.doi.org/10.1007/978-981-19-3895-5\\_22](http://dx.doi.org/10.1007/978-981-19-3895-5_22)

James, J., Sivapriya, S.V, and Eyo, E, (2023), "Stress-Strain Characteristics and Mineralogy of an Expansive Soil Stabilized Using Lime and Phosphogypsum", Applied Sciences, Vol. 13, 123, (2076-3417) doi: 10.3390/app13010123.

Pauline T., Sangeetha P., Janardhanan G. & Ashok V. (2022) Experimental & analytical behaviour and performance of structural joints retrofitted with woven wire mesh concreting under reversed cyclic loading, European Journal of Environmental and Civil Engineering, 26:16, 8561-8583, DOI: 10.1080/19648189.2022.2112623

Sangeetha P., (2022), " Assessment of air quality index and pollutants in Chennai city, India: Pre-Covid and during- Covid period", Proceedings of the International Academy of Ecology and Environmental Sciences, Vol. 12(4), pp. 269-280, ISSN: 2220-8860.

Abidhan Bardhan, Abdel Kareem Alzo'ubi, Sangeetha Palanivelu, Pouria Hamidian, Anasua GuhaRay, Gaurav Kumar, Markos Z. Tsoukalas and Panagiotis G. Asteris(2023), "A hybrid approach of ANN and improved PSO for estimating soaked CBR of subgrade soils of heavy-haul railway corridor", International Journal of Pavement Engineering, Taylor & Francis Online Vol. 24, No. 1, 2176494, (Scopus) <https://doi.org/10.1080/10298436.2023.2176494>

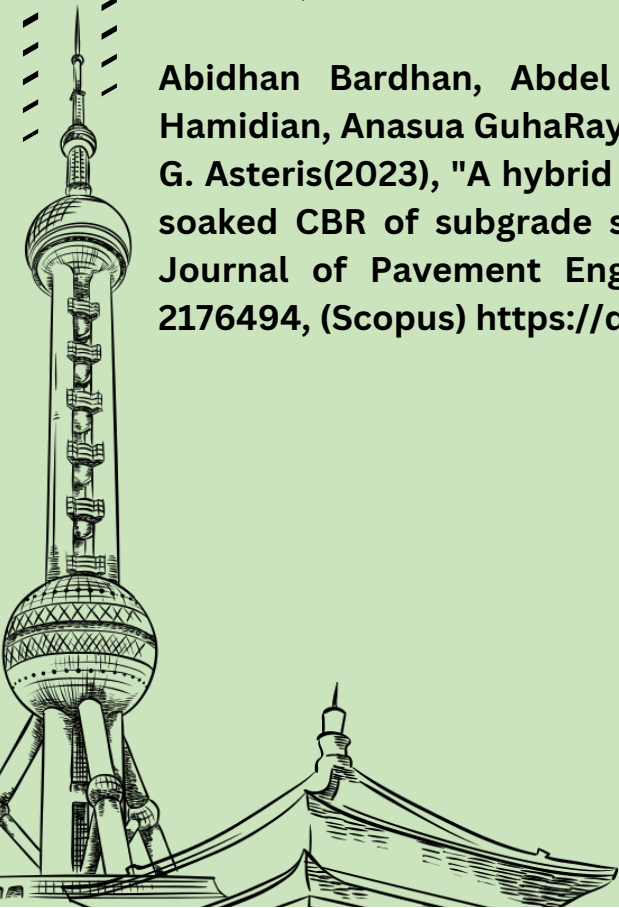



## 9. CONFERENCES

Kesavan J, Sanjayrathinam M, Mahalingam B, Sivakumar N., (2023), "Workability of Concrete with Partial Replacement of Bagasse ASH and Blended Mix of Standard Sand ", In: Proceedings of the International Conference on "Sustainable Practices And Innovations In Civil Engineering Spice2023", Conference 23,24th March 2023, SSNCE, Department of Civil Engineering, Knowledge Curve, Chennai, pp. 42, ISBN: 978-93-84389-35-2.

Dr. R.Rajkumar (2023), "Performance based design of RCC Framed Structures" Proceedings of 4th International conference on sustainable practices and innovations in civil Engineering SPICE 2023, March 23 and 24, 2023, SSN College of Engineering, Chennai, PP 33.

Dr. Srinath Rajagopalan, Mahalingam B., (2023), " Thermo-mechanical effects of waste rubber tire chips replacements in uniform and gap graded aggregate concrete ", In: Proceedings of the International Conference on "Sustainable Practices And Innovations In Civil Engineering Spice2023", Conference 23,24th March 2023, SSNCE, Department of Civil Engineering, Knowledge Curve, Chennai, pp. 42, ISBN: 978-93-84389-35-2.

Dr. Sivapriya S.V., James, J., Naveen Prasath, M., and Taniskha Ramesh, (2022), "Effective reuse of concrete debris in soil-column study", In: Proceedings of Advances in Construction Materials and Management - 2022, (ACMM), December 16-17, National Institute of Technology - Warangal, India.

Dr. Sivapriya S.V, Ragesh Raj M, Dhanushvarman J, Gokul S, (2023), "Analysis of Secant Pile During Underground Excavation – A Numerical Study", In: Proceedings of International Conference on Civil Engineering Innovative development in Engineering Advances, March 9 -10, Chennai, India.

Dr. Sivapriya S.V, (2023), "Influence of Slope in Modulus of Laterally Loaded Single Pile", In: Proceedings of International Conference on Civil Engineering Innovative development in Engineering Advances, March 9 -10, Chennai, India.  
Karthick Vikram I and Sivapriya S.V (2023), "The Engineering Magnificence of An Ancient Temple in Tamil Nadu ", In: Proceedings of SPICE – 2023, March 23 and 24, Chennai, India.

**Dr. Sivapriya S.V, Jeyashree D and Shaleni Elam Thendral A (2023), "Study on Desiccated Cracks on Expansive Soil Treated with Nano Alumina ", In: Proceedings of SPICE – 2023, March 23 and 24, Chennai, India.**

**Dr.Sivapriya S.V, Meenaksi V, Rupashri V, Bharathi M and Santhosh Kumar R (2023), "Investigating the bio-gas collection from foodwaste", In: Proceedings of National Conference on Sustainable Trends in Energy and Environmental Resources – 2023, March 16 and 17, Chennai, India.**

**Adarsh C, Adithya V & Sangeetha P, (2023), "Numerical Investigation on the Behavior of the Cold-formed Steel Channel Beam with Closer and Intermediate Stiffeners", In: Proceedings of International Conference on Sustainable Practices and Innovations in Civil Engineering (SPICE 2023) held on 23rd and 24th March 2023, Chennai, India, pp.34. ISBN: 978-93-84389-35-2**

**Dr. Sangeetha P, (2023), " Effect of Intermediate Stiffener on Ultimate Behavior of the Cold-formed Steel Columns under axial Compression - Numerical Study", In: Proceedings of International Conference on Sustainable Practices and Innovations in Civil Engineering (SPICE 2023) held on 23rd and 24th March 2023, Chennai, India, pp.35. ISBN: 978-93-84389-35-2**

**Dr. James, J., Kumar, B. M., Samundeeswari, P., Selvi, R.S., and Abhivandya, C.K.S., (2023), “Early Strength of an Expansive Soil Stabilized Using a Combination of Hydrated Lime, Unrefined Brown Sugar and Ground Gallnut Dust Under Varying Curing Conditions”, In: Proceedings of International Conference on Civil Engineering Innovative Development in Engineering Advances, March 9 -10, SRM Institute of Science and Technology, Chennai, India.**

**Dr. Surendar Natarajan (2023), "Identification of Groundwater Potential Zone by Analytical Hierarchical Process- Case Study in Chengalpattu District, Tamil Nadu", An Indo Canadian Symposium on “Water Management: Sustainability & Impact of Climate Change” at IIT Tirupathi , on March 6-7-2023**

**Dr. Surendar Natarajan Internet of Things (IOT)-Based Sustainable Agriculture in 4th International Conference on Sustainable Practices and Innovations in Civil**

Engineering 2023 Proceedings (SPICE 2023) at SSN College of Engineering, Kalavakkam, ISBN: 978-93-84389-35-2

Dr. Surendar Natarajan (2023) Prediction of Canal Discharge Using Machine Learning Techniques in 4th International Conference on Sustainable Practices and Innovations in Civil Engineering 2023 Proceedings (SPICE 2023) at SSN College of Engineering, Kalavakkam, ISBN: 978- 93-84389-35-2

Dr. Surendar Natarajan (2023) Ease of Access and Survey of Health Care Facilities Using Geo-Spatial Techniques 4th International Conference on Sustainable Practices and Innovations in Civil Engineering 2023 Proceedings (SPICE 2023) at SSN College of Engineering, Kalavakkam. ISBN: 978-93-84389-35-2

Dr. Surendar Natarajan (2023) Identification of Groundwater Potential Zone by Analytical Hierarchical Process- Case Study in Selected Regions of OMR, Tamil Nadu 4th International Conference on Sustainable Practices and Innovations in Civil Engineering 2023 Proceedings (SPICE 2023) at SSN College of Engineering, Kalavakkam. ISBN: 978-93-84389-35-2

## 10. FACULTY ACTIVITIES

### 10.1 Research Grant

The external funding for the student project title " Structural behaviour of deficient hollow steel stub columns strengthened using GFRP " was screened by Tamil Nādu State Council for Sci ence and Technology for the amount of Rs.7,500/= (Name of the Student: Sathya Shree T R, Rakshana SN and S Sadhana & Guide: Dr.P.Sangeetha)

### 10.2 External Recognition

Dr. N. Sivakumar has delivered a lecture for a seminar on " Introduction to IGBC green new buildings rating system" on 7 Feb 2023.

Dr. N. Sivakumar has delivered a talk on "Current trends in civil engineering research" in a workshop organised by the dept of civil engineering SSNCE on 15th Feb 2023.

**Dr. N. Sivakumar has been appointed as the Guest Editor for the Special Issue "Emerging Technologies to Promote Sustainability and Mitigate Climate Change through Asset Lifecycle", journal of sustainability published by MDPI journal.**

**Dr. N. Sivakumar was nominated as a member of the Board of Studies of "Velammal Engineering college, Surapet Chennai" on "13.01.2023":**

**Dr.B.Mahalingam has attended as a session Chair International Conference on Sustainable Environment & Civil Engineering (ICSECE'23) – 30.03.23 at SRM Eeswari Engineering College, Chennai**

**Dr.B.Mahalingam has attended as a session Chair International Conference Sustainable Practices And Innovations In Civil Engineering (Spice23) – 30.03.23 at Sri Sivasubramaniya Nadar College of Engineering, Chennai.**

**Dr.B.Mahalingam has attended as an Examiner for the Ph.D Viva Voce Examination Mr. S. Kotteswaran (RA1913001011004) on 15.03.2023 at Department of Civil Engineering, SRM Institute of Science and Technology, Kattankulathur -603203, Chennai.**

**Dr. R. Rajkumar has been recognized as supervisor of Anna University for guiding Ph.D Scholars under the Faculty of Civil Engineering.**

**Dr. R. Rajkumar has been appointed as Question paper setter in Civil Engineering for St.Joseph's College of Engineering(Autonomous) and Paavai Engineering College (Autonomous)**

**Dr.R.Rajkumar has delivered an expert talk for the FDTP conducted by Department of Civil Engineering, SSN College of Engineering on February 03, 2023.**

**Dr. Sivapriya S.V. won the "Best paper award" for her paper presented in the "International Conference on Civil Engineering Innovative development in Engineering Advances, SRMISTE" on "March 9 - 11" in a function held at "SRMISTE, Kattangulathur".**

Dr. S. V. Sivapriya has delivered an invited lecture titled "Innovative materials for stabilization of problematic soil" as a part of "National Seminar on Recent Advancements in Ground Improvement Techniques for Problematic Soil" organized by "B.S.Abdur Rahman Crescent Institute of Science and Technology" on "23.05.2023" held at "Chennai".

Dr. P. Sangeetha has joined the editorial board of the Journal of Environmental and Public Health as Academic Editor

Dr. P. Sangeetha has delivered an invited expert talk "Flexibility and Stiffness Matrix Method" as a part of "Faculty Development Programme on Structural Analysis - II" organized by "Department of Civil Engineering, on "31st Jan 2023 & 3rd Feb 2023" held at SSN College of Engineering.

Dr. P. Sangeetha acted as an expert member in framing the Curriculum for Polytechnic colleges in Tamil Nādu held at Central Polytechnic College, Taramani on 27/03/2023 organised by DOTE and Government of Tamil Nādu along with M/s. Forge agencies.

Dr. Jijo James was invited and has joined the editorial board as an academic editor of the journal 'The Scientific World Journal – Civil Engineering' published by Hindawi Publishing Corporation.

Dr. Jijo James was recognized for his contributions as an academic editor in the calendar year 2022 by the journal 'Advances in Civil Engineering' published by Hindawi Publishing Corporation.

Dr. Jijo James was invited and has joined the Editorial Board of the journal 'PLOS One' published by Public Library of Science as Academic Editor.

Dr. Jijo James has been appointed as a doctoral committee panel member for monitoring the research progress of the scholar Ms. M. Meenakumari pursuing her Ph.D., in VIT University, Chennai.

Dr. Jijo James was invited and has joined the editorial board of the Journal of Engineering published by Hindawi Publishing Corporation.

Dr. Surendar Natarajan delivered Guest Lecture for Multi-Disciplinary Faculty Development Programme on Sprouting Trends in Technologies at Mohamed Sathak Engineering College -Ramanathapuram at Topic "Introduction to Geo-Spatial Techniques".

**Dr. Surendar Natarajan Acted as Judges of the Inter College Debate Competition Conducted by SSN-EDC Lakshya on 10-2-2023".**

**Dr. Surendar Natarajan Acted as Resource Person on Invited lecture on "Integrating Geo-spatial and ML Techniques in Irrigation & Water Resources Engineering" (Virtual) held on 6th April 2023 at Ramco Institute of Technology.**

### **10.3 Research Scholar related.**

**Dr. B. Mahalingam attended the DC meeting of the scholar, "M. Mugesh" pursuing his Ph.D., programme under "SRMIST" on "21.12.22" at 2 p.m held via "ZOOM/Online platform"**

**Dr. B. Mahalingam attended the DC Synopsis meeting of the scholar, "Lokaprakash" pursuing his Ph.D., programme under "SRMIST" on "22.12.22" at 10 am held via "ZOOM/Online platform"**

**Dr. Sivapriya S V attended Synopsis meeting of the scholar Ms. V. Janani - PA1913001012003 of SRMIST on 06.01.2023 through online mode.**

**Dr. S.V. Sivapriya attended the comprehensive exam of Mr.R.Dinesh Kumar, of SRMISTE, Kattankulanthur, Chennai.**

**Dr. P. Sangeetha has Conducted Viva Voce examination as Joint Supervisor for Mrs. Pauline T, at NITTTR Taramani on 18/05/2023 - FN, registered under Anna University.**

### **10.4 Workshop/Webinar attended.**

**Dr. N. Sivakumar attended an Online Webinar on 'Research methods and proposal preparation' held on 30th Dec 2022, organized by Dept. of Civil Engineering, Velammal engineering college, Chennai.**

**Dr. N. Sivakumar has attended a Webinar on "selection of suitable chemical admixture for enhancing its performance in concrete" conducted by Ultratech Cement ltd on 25/2/2023.**

**Dr. N. Sivakumar has attended a Webinar on "Sustainable construction materials towards net zero carbon" on 18/3/2023 by Ultratech Cement Ltd.**

**Dr. B. Mahalingam attended an online Webinar on 'Design of RC Building with STADD' held on 06th Nov 2022, organized by Skill lync, Chennai.**

**Dr. Jijo James attended a webinar titled “Water Audit”, organized by Ultratech Cement Ltd. On December 3rd, 2022.**

**Dr. Jijo James attended a course design workshop on the 19th and 20th of January 2023 organized by the SSN School of Advanced Career Education.**

**Dr. Surendar Natarajan attended a course design workshop on the 19th and 20th of January 2023 organized by the SSN School of Advanced Career Education.**

### **10.5 FDP**

**Dr. B. Mahalingam has attended FDP on "Making Villages Smart' held from 13th to 17th February 2023 (One Week), organized by National Institute of Technical Teachers Training Institute, Chandigarh and Dept. of Civil Engineering, SRM Eswari Engineering, Chennai.**

**Dr. R. Vijayalakshmi has attended 5-day Online FDP on “Inculcating Universal Human Values in Technical Education” from 30th January to 3rd February 2023, organized by All India Council for Technical Education (AICTE)**

**Dr. R. Vijayalakshmi has participated and successfully completed the 6-day Online UHV-II FDP organized by All India Council for Technical Education (AICTE) from 10th April to 15th April 2023.**

### **10.6 Events Conducted**

**Dr. S. Ramana Gopal and Dr. P. Sangeetha have organized a Seminar on the topic "Steel and Composite Structures" on 21st Feb 2023 for III- year and IV- year students under the banner of " ICI Student Chapter".**

**Dr. R. Srinath has organized a seminar on "Introduction to IGBC green new buildings rating system" on 7th Feb 2023.**

**Dr. Srinath Rajagopalan, along with Dr. Surendar N and Dr. Aswin Sriram G organized an International Conference on "Sustainable Practices and Innovations in Civil Engineering" on 23rd and 24th March 2023.**

Dr. S.V.Sivapriya has organized a seminar to "Second Year" on "03.05.2023" at "Department Seminar Hall" under the banner of "Association of Civil Engineers"

Dr. P. Sangeetha and Dr. Jijo James have organized a One Day Online workshop on " Current Trends in Civil Engineering Research" on 15th Feb 2023 under the banner of " ICI Student Chapter".

Dr. Jijo James organized a two-day online workshop on 'Introduction to ACCA Software and BIM Authoring Solution' on the 13th and 14th of March 2023 under the banner of the ICE Students Chapter.

Dr. Aswin Sriram has organized a two-day Workshop titled "Introduction to Building Information Modelling" on 13th and 14th February 2023 by Wallflower Design for Third year civil Engineering students.

Dr. Aswin Sriram G organized a webinar titled "Successful Career Planning, Higher Education & Technical Profile Building" for Third Year students of B.E., Civil Engineering under the banner of IEI students' chapter.

## 10.7 Industry Collaboration

Dr. S.V. Sivapriya provided consultancy services for M/s. Minerva Testing Company, Chennai for soil report generation for an amount of Rs. 7200.

Dr.P.Sangeetha carried out consultancy work to Ms. R.S. Construction, for analyses and design of structural components to a residential building for Rs.10,000/- in the month of May 2023.

Dr. Surendar Natarajan completed a Consultancy Work for an amount of Rs. 50,000/- on Developing Rainfall Runoff Modeling for Extreme Rainfall Events - A Study on Proposed Kakinada SEZ (KSEZ) Area in Andhra Pradesh funded by IIT Madras.

Dr.Surendar Natarajan Applied for Climate Change Impact on Water Resources Engineering in TARE Scheme-SERM March 2023



## 10.8 Notable Visitors

Dr Janarthanan, Professor, NITTTR Chennai has delivered a talk on the topic Educational Technology -II on 30.01.2023.

Dr. R Senthil Selvan, Professor, SRMIST, Chennai has delivered a lecture on the topic ILD for Determinate Structures Structural Analysis II on 30.01.2023.

Dr. Gajalakshmi, Professor B S Abdur Rahman Crescent Institute of Science and Technology, Vandalur, Chennai, has delivered a lecture on the topic “Arches - Types of arches – Analysis of three hinged, two hinged and fixed arches” on 01.02.2023.

Er. Mr. Balamourougane, Consultant - Head Structural Applications TechApps Consulting, Chennai has delivered a talk on the topic “Analysis of Plate Girders using STADD pro Connect – Industry Expert on 01.02.2023.

Dr. R. Senthil, Professor, Division of Structural engineering, CEG, Anna University, Chennai has delivered a talk on Structural Analysis II on 02.01.2023.

Dr. Rupen Goswami, Professor, Department of Civil Engineering, IIT Madras, Chennai has delivered a talk in the Seminar on Steel and Concrete Composites held on 21.02.2023.

Dr. S. Vishnuvardhan, Principal Scientist, Fatigue and Fracture Laboratory, CSIR-Structural Engineering Research Centre, Chennai, has delivered a talk in the Seminar on Steel and Concrete Composites held on 21.02.2023.

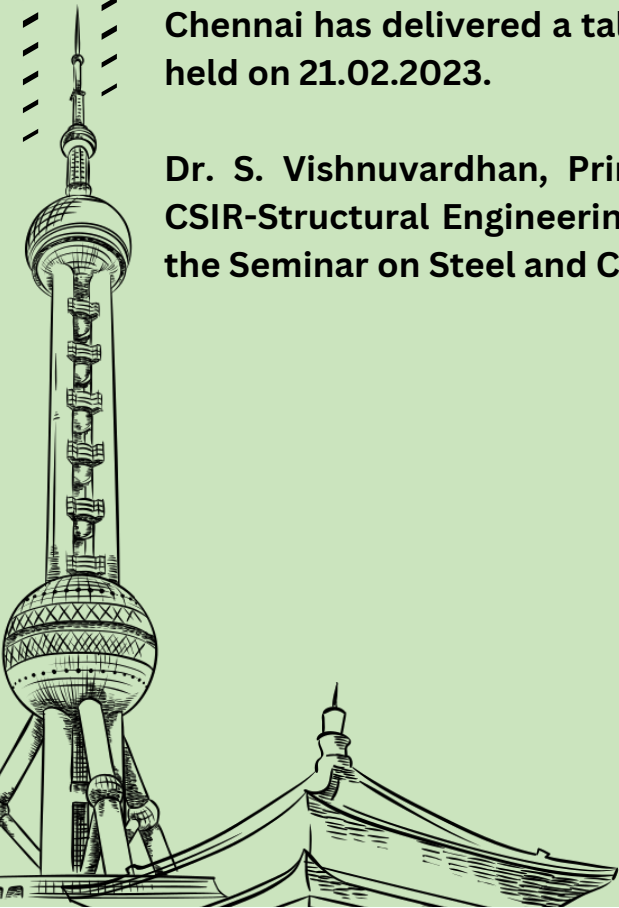

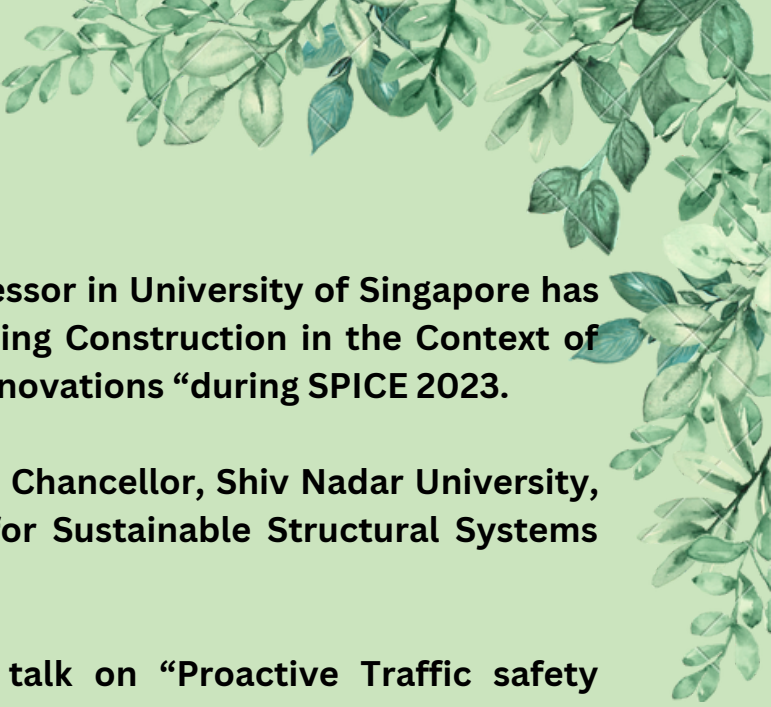

**Dr. Rajasekhar Balasubramanian, Professor in University of Singapore has delivered a talk on “Sustainable Building Construction in the Context of Changing Climate: Opportunities for Innovations “during SPICE 2023.**

**Dr. Sriman Kumar Bhattacharyya, Vice Chancellor, Shiv Nadar University, has delivered a talk on “Challenges for Sustainable Structural Systems and way forward” during SPICE 2023.**

**Dr. P. Vedagiri IIT, has delivered a talk on “Proactive Traffic safety Evaluation: Innovative Methods and Tools.” during SPICE 2023.**

**Dr. Venkata Reddy, National Institute of Technology, Warangal has delivered a talk on “Real Time forecasting of flow in Watersheds: Methods, Data, Applications” during SPICE 2023.**

**Dr .C.Velan, City Head at CapitaLand Investment India has visited our college on 25.05.2023 as Annual Celebration Day Guest.**

## **10.9 Other Activities**

**Dr. N. Sivakumar reviewed one paper for Construction and Building Materials, Elsevier.**

**Dr. N. Sivakumar reviewed one paper for Structural engineering and Mechanics, an International Journal by Techno Press.**

**Dr. N. Sivakumar reviewed one paper on 29th December 2022 for the journal Construction and Building Materials published by Elsevier.**

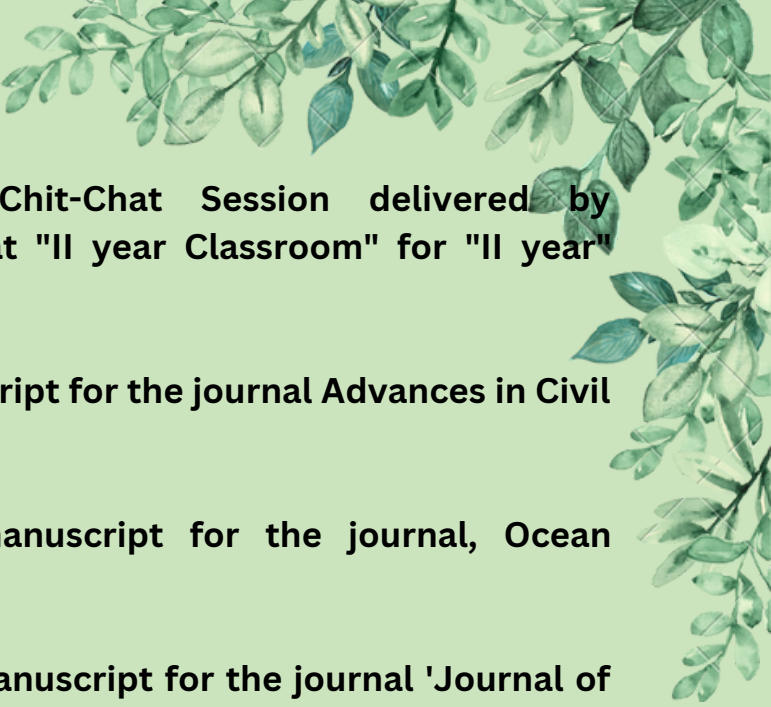

Dr. S.V. Sivapriya Organized a Chit-Chat Session delivered by "Mr.Dhanush" on "26.12.2022" held at "II year Classroom" for "II year" under the banner of "KRACIVA".

Dr. Sivapriya S V reviewed one manuscript for the journal Advances in Civil Engineering published by Hindawi.

Dr. Sivapriya S V reviewed one manuscript for the journal, Ocean Engineering, published by Elsevier B V.

Dr. S.V. Sivapriya has reviewed one manuscript for the journal 'Journal of Engineering Science' published by JES.

Dr. S.V. Sivapriya has organized an event titled "Connexion" on "29.01.2023" held at "III-year Classroom" for "2,3 and 4 Year students" under the banner of "Association of Civil Engineers".

Dr. S. V. Sivapriya organized an event titled "Wordle" on "22.02.2023" held at "III-year Classroom" for "3 and 4 Year students" under the banner of "Kraciva"

Dr. S. V. Sivapriya organized a Chit-Chat Session delivered by "Prabhakaran. P, Data Analyst, Latentview Analytics Ltd.," on "23.02.2023" held via "Online platform" for "2,3 and 4 Year of students" under the banner of "Association of Civil Engineers".

Dr. S. V. Siva Priya organized a Chit-Chat Session "Chit-Chat Session" on "18.03.2023" for "2,3 and 4 year students" under the banner of "KRACIVA".

Dr. S.V. Sivapriya has reviewed two manuscripts for the International Conference on Civil Engineering Innovative Development in Engineering Advances" organized by SRMISTE, Kattankulathur, Chennai.

Dr. S.V.Sivapriya has organized farewell to "Final year" on "12.05.2023" at "Department Seminar Hall" under the banner of "Association of Civil Engineers".



**Dr. P. Sangeetha reviewed one manuscript for the International Journal of Steel Structures published by Springer Nature.**

**Dr. P. Sangeetha reviewed one manuscript for the journal, Materials Today: Proceedings, published by Elsevier B V.**

**Dr. P. Sangeetha has reviewed One manuscript for the International Journal of Engineering and Technology Innovation published by OJS/PKP.**

**Dr. P. Sangeetha has reviewed One manuscript for the Physical Science International Journal published by Academic Press.**

**Dr. Sangeetha has reviewed one manuscript for the Journal of Materials and Engineering Structures.**

**Dr. Sangeetha has reviewed one manuscript for the Journal Materials Todays Proceedings.**

**Dr. Sangeetha has reviewed one manuscript for the Journal Steel Concrete and Composites.**

**Dr. Sangeetha has reviewed one manuscript for the Journal Cogent Engineering.**

**Dr. Sangeetha has reviewed one manuscript for the International Journal of Engineering and Technology Innovation.**

**Dr. P. Sangeetha has organized a National Level Technical event "ICI TECH FEST" on 25/04/2023, under the banner of ICI Student Chapter of SSN College of Engineering.**

**Dr. P. Sangeetha has reviewed one manuscript for the Journal of Engineering Research and reports published by JEER publisher.**

**Dr. P. Sangeetha has reviewed One manuscript for the journal 'Congent Engineering' published by Taylor and Francis.**

**Dr.P.Sangeetha has reviewed One manuscript for the journal 'Innovative Infrastructure Solutions' published by Springer.**

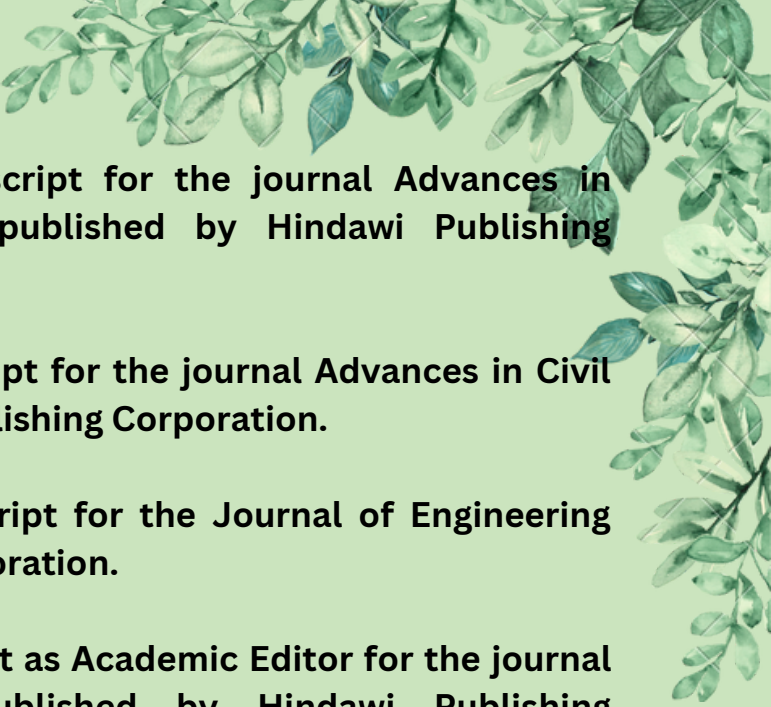

Dr. Jijo James reviewed one manuscript for the journal **Advances in Material Science and Engineering** published by Hindawi Publishing Corporation.

Dr. Jijo James reviewed one manuscript for the journal **Advances in Civil Engineering** published by Hindawi Publishing Corporation.

Dr. Jijo James reviewed one manuscript for the **Journal of Engineering** published by Hindawi Publishing Corporation.

Dr. Jijo James handled one manuscript as Academic Editor for the journal **Advances in Civil Engineering** published by Hindawi Publishing Corporation.

Dr. Jijo James reviewed one manuscript for the **Journal of Thermoplastic Composite Materials** published by Sage Publishing.

Dr. Jijo James reviewed one manuscript for the journal, **Advances in Civil Engineering**, published by Hindawi Publishing Corporation.

Dr. Jijo James handled one manuscript as academic editor for the journal, **Advances in Civil Engineering**, published by Hindawi Publishing Corporation.

Dr. Jijo James reviewed a manuscript for the journal **Multiscale and Multidisciplinary Modelling, Experiments and Design** published by Springer Nature.

Dr. Jijo James has reviewed one manuscript for the **Journal Geotechnics** published by MDPI.

Dr. Jijo James has reviewed one manuscript for the **Journal Multiscale and Multidisciplinary Modeling, Experiments and Design** published by Springer Nature.

Dr. Jijo James has completed an editorial decision as academic editor for a manuscript submitted to **The Scientific World Journal** published by Wiley-Hindawi.

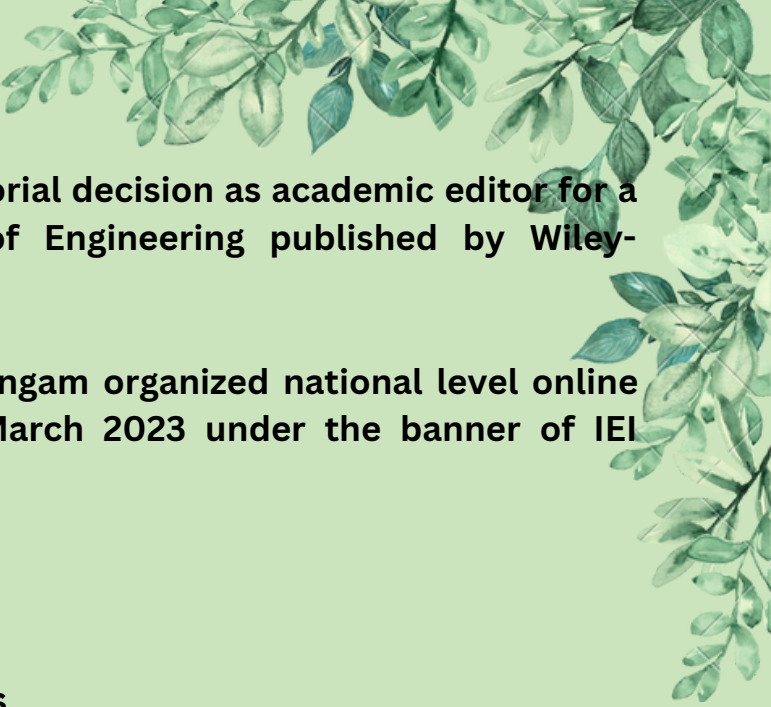

Dr. Jijo James has completed an editorial decision as academic editor for a manuscript submitted to Journal of Engineering published by Wiley-Hindawi.

Dr. Aswin Sriram G and Dr. B. Mahalingam organized national level online poster presentation competition in March 2023 under the banner of IEI student's chapter.

## **11. STUDENT ACTIVITIES**

### **11.1 Students Co-curricular Activities**

Magendra Kamalnath S A, III Year, served as mentor in 2022 AMD Hackathon conducted by Shooting Stars Foundation.

Hariharan K, II Year, attended workshop on entrepreneurship development on 17th December 2022 organized by Midas School of Entrepreneurship.

C. Adarsh attended a webinar on "Durability parameters-option and Status " Conducted by Qcrete Readymix India on DATE:15.12.2022

C. Adarsh attended a webinar on "Water Audit" Conducted by Ultratech Cements India on DATE: 3.12.2022

C. Adarsh attended a webinar on "Performance based specification for concrete structures " Conducted by Ultratech Cements India on DATE: 17.12.2022

C. Adarsh attended a webinar on "Self-compacting concrete and Speciality Products" Conducted by Ultratech Cements India on DATE: 24.12.2022

C. Adarsh has got appreciation certificate for organizing the Workshop hosted by Er. Ashok Kumar on the topic "Entrepreneurship and Career development" on DATE: 29.11.2022

C. Adarsh has completed a course on "Essentials in Construction Management using MSP " from CADD Centre Velachery, in the duration of 4 weeks from 8th September to 1st October.



**Naveen Prasath M, IV Year, presented a paper on the topic on "Effective Reuse of Concrete Debris in Soil-Column Study" at ACMM Conference happened at NIT Warangal on 16th of December 2022.**

**R Hemalatha, II Year, participated in the second International Conference on Mathematical Analysis and Computing, held between December 22 to 23, 2022 at SSN College of Engineering, Chennai.**

**S Archana, II Year, participated in the second International Conference on Mathematical Analysis and Computing, held between December 22 to 23, 2022 at SSN College of Engineering, Chennai.**

**N Annamalai, II Year, participated and presented a paper titled "An Efficient Algorithm to Solve General Lane-Emden Equations" in the second International Conference on Mathematical Analysis and Computing, held between December 22 to 23, 2022 at SSN College of Engineering, Chennai.**

**B. Rajalakshmi, II Year, participated in the event 'Marketize' conducted by EDC Lakshya, on the 25th of November 2022, at SSN College of Engineering, Chennai.**

**Yogashree Muthusami, III Year participated in the UNLEASH Hackathon organized by Shiv Nadar University IOE, Noida from 4th November 2022 to 6th November 2022.**

**Krishnasree A, III Year, participated in the UNLEASH Hackathon organized by Shiv Nadar University IOE, Noida from 4th November 2022 to 6th November 2022.**

**Shalini Elamthendral, IV Year, completed an online training programme on Preparation of Bar Bending Schedules from 18th to 26th December 2022 through Construction Management Training Institute.**

**Bharathi M, IV Year, completed an online training programme on Preparation of Bar Bending Schedules from 18th to 26th December 2022 through Construction Management Training Institute.**

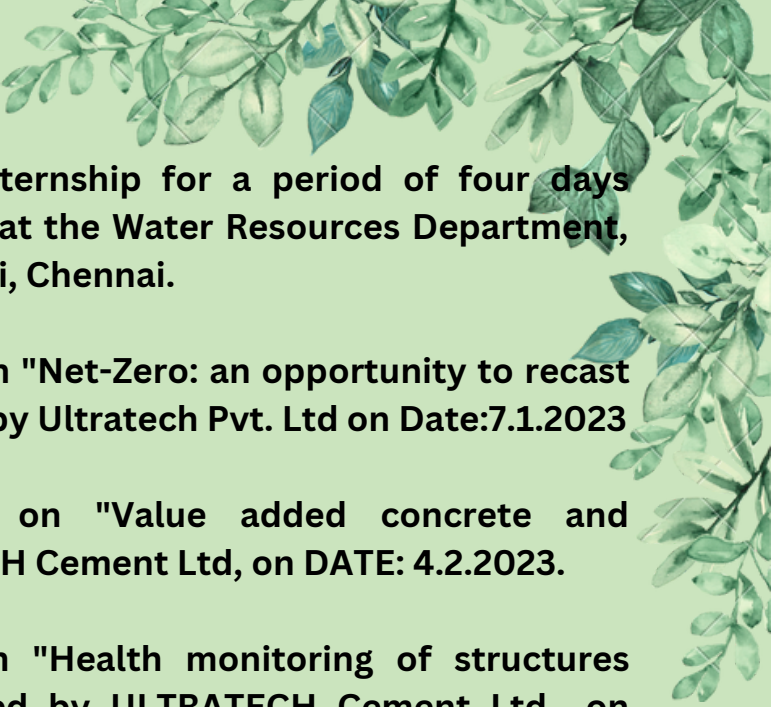

➔  
**Jemimah J, III Year, attended an internship for a period of four days between 10th and 14th January 2023 at the Water Resources Department, Government of Tamil Nadu at Taramani, Chennai.**

**C. ADARSH, has attended a webinar on "Net-Zero: an opportunity to recast Indian Concrete Industry" Conducted by Ultratech Pvt. Ltd on Date:7.1.2023**

**C. Adarsh has attended Webinar on "Value added concrete and Application", Conducted by ULTRATECH Cement Ltd, on DATE: 4.2.2023.**

**C. Adarsh has attended Webinar on "Health monitoring of structures through Instrumentation ", Conducted by ULTRATECH Cement Ltd., on DATE: 11.2.2023.**

**C. ADARSH has attended Webinar on "Preservation, Conservation and Restoration of Heritage Structures ", Conducted by ULTRATECH Cement Ltd., on DATE: 18.2.2023.**

**Raviraam S of Second yr. has organized a workshop on "Introducing to ACCA software and BIM authoring solution "on 13th and 14th of March 2023.**

**Raviraam S of II yr. has Completed Staad.pro connect basic RCC design and analysis from Bentley on 19th March 2023.**

**Nishta M N of II year had participated in a Workshop on "Introducing to ACCA software and BIM authoring solution "on 13th and 14th of March 2023.**

**C. Adarsh, has attended a Webinar on "Selection Of Suitable Chemical Admixture For Enhancing Its Performance In Concrete ", Conducted By Ultratech Pvt Ltd., on DATE :25.02.2023**

**C. Adarsh, has attended a Webinar on "Modern assessment tools for de-risking of project cost ", conducted by Ultratech Pvt Ltd., on DATE :4.03.2023**

**C. Adarsh, has attended a Webinar on" Constructing high performance concrete floor and suitable treatment for performance enhancement ", conducted by Ultratech Pvt Ltd., on DATE: 11.03.2023**





**C. Adarsh, has attended a Webinar on "Sustainable construction materials towards net zero carbon", conducted by ULTRATECH Pvt Ltd., on DATE :18.03.2023**

**C. Adarsh, has attended a Webinar on "Expansion joints and bearing of bridges ", conducted by Ultratech Pvt Ltd., on DATE: 5.03.2023**

**C. Adarsh, has attended a Workshop on "Introducing to ACCA software and BIM authoring solution", conducted by ICE-SSN student chapter., on DATE :13th and 14th march 2023**

**C. Adarsh, has won Second place in Art competition conducted by MIT Tamil Mandram during MITAFEST 2023 on 5.03.2023**

**Karthick Vikraam I of second year has attended a workshop on "Introducing to ACCA software and BIM authoring solution "on 13th and 14th of March 2023.**

**Saarusha G.S has attended Workshop on Introduction to ACCA software and BIM Authoring solutions on 13th and 14th of March 2023.**

**Raviraam S has attended a workshop from "SKILL LYNC" using the software STAAD PRO on 21.03.2023.**

**Pandiarajan P of III year had participated in a Workshop on "Introducing to ACCA software and BIM authoring solution "on 13th and 14th of March 2023.**

**Archana S of II year had participated in a Workshop on "Introducing to ACCA software and BIM authoring solution "on 13th and 14th of March 2023.**

**Balaji S of II year had participated in a Workshop on "Introducing to ACCA software and BIM authoring solution "on 13th and 14th of March 2023.**

**Elanthalir A of II year had participated in a Workshop on "Introducing to ACCA software and BIM authoring solution "on 13th and 14th of March 2023.**



➔  
**M Eka Vardhan of II year had participated in a Workshop on "Introducing to ACCA software and BIM authoring solution "on 13th and 14th of March 2023.**

**Gaayathri Sangavi G of III year had participated in a Workshop on "Introducing to ACCA software and BIM authoring solution "on 13th and 14th of March 2023.**

**Gowda Bhuvaneshwar of II year had participated in a Workshop on "Introducing to ACCA software and BIM authoring solution "on 13th and 14th of March 2023.**

**Hariharan K of II year had participated in a Workshop on "Introducing to ACCA software and BIM authoring solution "on 13th and 14th of March 2023.**

**Jeevitha R of II year had participated in a Workshop on "Introducing to ACCA software and BIM authoring solution "on 13th and 14th of March 2023.**

**K Govindaraj of II year had participated in a Workshop on "Introducing to ACCA software and BIM authoring solution "on 13th and 14th of March 2023.**

**Karan K of III year had participated in a Workshop on "Introducing to ACCA software and BIM authoring solution "on 13th and 14th of March 2023.**

**Karthikeyan J of II year had participated in a Workshop on "Introducing to ACCA software and BIM authoring solution "on 13th and 14th of March 2023.**

**Karthikeyan M S of II year had participated in a Workshop on "Introducing to ACCA software and BIM authoring solution "on 13th and 14th of March 2023.**

**Kavin S of III year had participated in a Workshop on "Introducing to ACCA software and BIM authoring solution "on 13th and 14th of March 2023**

**Keerthana A of III year had participated in a Workshop on "Introducing to ACCA software and BIM authoring solution "on 13th and 14th of March 2023.**



**Kraanisha S of II year had participated in a Workshop on "Introducing to ACCA software and BIM authoring solution "on 13th and 14th of March 2023.**

**Kuchi Phani Soumika of III year had participated in a Workshop on "Introducing to ACCA software and BIM authoring solution "on 13th and 14th of March 2023.**

**Lavanya J of III year had participated in a Workshop on "Introducing to ACCA software and BIM authoring solution "on 13th and 14th of March 2023.**

**Lokesh Krishna E J of II year had participated in a Workshop on "Introducing to ACCA software and BIM authoring solution "on 13th and 14th of March 2023.**

**M Dhuvarakesh of II year had participated in a Workshop on "Introducing to ACCA software and BIM authoring solution "on 13th and 14th of March 2023.**

**Meer Ismail Shoaib H of II year had participated in a Workshop on "Introducing to ACCA software and BIM authoring solution "on 13th and 14th of March 2023.**

**Muhammed Fatheen of II year had participated in a Workshop on "Introducing to ACCA software and BIM authoring solution "on 13th and 14th of March 2023.**

**Murali B of III year had participated in a Workshop on "Introducing to ACCA software and BIM authoring solution "on 13th and 14th of March 2023.**

**N Jewison Jacob of II year had participated in a Workshop on "Introducing to ACCA software and BIM authoring solution "on 13th and 14th of March 2023.**

**N Yashmitha of II year had participated in a Workshop on "Introducing to ACCA software and BIM authoring solution "on 13th and 14th of March 2023.**



**N Annamalai of II year had participated in a Workshop on "Introducing to ACCA software and BIM authoring solution "on 13th and 14th of March 2023.**

**Naresh Mohan of III year had participated in a Workshop on "Introducing to ACCA software and BIM authoring solution "on 13th and 14th of March 2023.**

**Nitesh M of III year had participated in a Workshop on "Introducing to ACCA software and BIM authoring solution "on 13th and 14th of March 2023.**

**Prasanna A K of II year had participated in a Workshop on "Introducing to ACCA software and BIM authoring solution "on 13th and 14th of March 2023.**

**R Anbunathan of II year had participated in a Workshop on "Introducing to ACCA software and BIM authoring solution "on 13th and 14th of March 2023.**

**R Hemalatha of II year had participated in a Workshop on "Introducing to ACCA software and BIM authoring solution "on 13th and 14th of March 2023.**

**R Rohan Krishna of II year had participated in a Workshop on "Introducing to ACCA software and BIM authoring solution "on 13th and 14th of March 2023.**

**Raheina A of II year had participated in a Workshop on "Introducing to ACCA software and BIM authoring solution "on 13th and 14th of March 2023.**

**Rajalakshmi B of II year had participated in a Workshop on "Introducing to ACCA software and BIM authoring solution "on 13th and 14th of March 2023.**

**S Harini of II year had participated in a Workshop on "Introducing to ACCA software and BIM authoring solution "on 13th and 14th of March 2023.**



**S Dakshetha of II year had participated in a Workshop on "Introducing to ACCA software and BIM authoring solution "on 13th and 14th of March 2023.**

**Sai Akshara of II year had participated in a Workshop on "Introducing to ACCA software and BIM authoring solution "on 13th and 14th of March 2023.**

**Santhosh Kumar S of II year had participated in a Workshop on "Introducing to ACCA software and BIM authoring solution "on 13th and 14th of March 2023.**

**Sarvesh Nikhil M of II year had participated in a Workshop on "Introducing to ACCA software and BIM authoring solution "on 13th and 14th of March 2023.**

**Srinidhi S of II year had participated in a Workshop on "Introducing to ACCA software and BIM authoring solution "on 13th and 14th of March 2023.**

**Srinidhi N of III year had participated in a Workshop on "Introducing to ACCA software and BIM authoring solution "on 13th and 14th of March 2023.**

**V Gowtham Yadav of II year had participated in a Workshop on "Introducing to ACCA software and BIM authoring solution "on 13th and 14th of March 2023.**

**Vanaja M J of III year had participated in a Workshop on "Introducing to ACCA software and BIM authoring solution "on 13th and 14th of March 2023.**

**Vignesh M of III year had participated in a Workshop on "Introducing to ACCA software and BIM authoring solution "on 13th and 14th of March 2023.**





**Vijay Pandian M of II year had participated in a Workshop on "Introducing to ACCA software and BIM authoring solution "on 13th and 14th of March 2023.**

**Vishvaa T of II year had participated in a Workshop on "Introducing to ACCA software and BIM authoring solution "on 13th and 14th of March**

**Yeshwanth D of II year had participated in a Workshop on "Introducing to ACCA software and BIM authoring solution "on 13th and 14th of March 2023.**

**Yogashree Muthusamy of III year had participated in a Workshop on "Introducing to ACCA software and BIM authoring solution "on 13th and 14th of March 2023.**

**Srinidhi N of III Year attended the inauguration of the South Asian ECNet of the ICE (UK) as a student representative for Chennai Region.**

**Amith Krishna, III yr Manikandan has attended an online course on green built environment on 13/04/2023 - 24/04/2023.**

**Amith Krishna, III yr Manikandan has cleared IGBC AP-ASSOCIATE EXAM on 15.04.2023.**

**C. Adarsh, attended webinar on "Innovative precasting techniques in signature bridge Delhi ", conducted by ULTRATECH Pvt. Ltd on DATE: April 1, 2023**

**C. Adarsh, attended webinar on " High strength fiber reinforced concrete", conducted by ULTRATECH Pvt. Ltd on DATE: April 15, 2023**

**C. Adarsh, attended webinar on "Latest techniques and trends in architecture for home building ", conducted by ULTRATECH Pvt. Ltd on DATE: April 19, 2023**

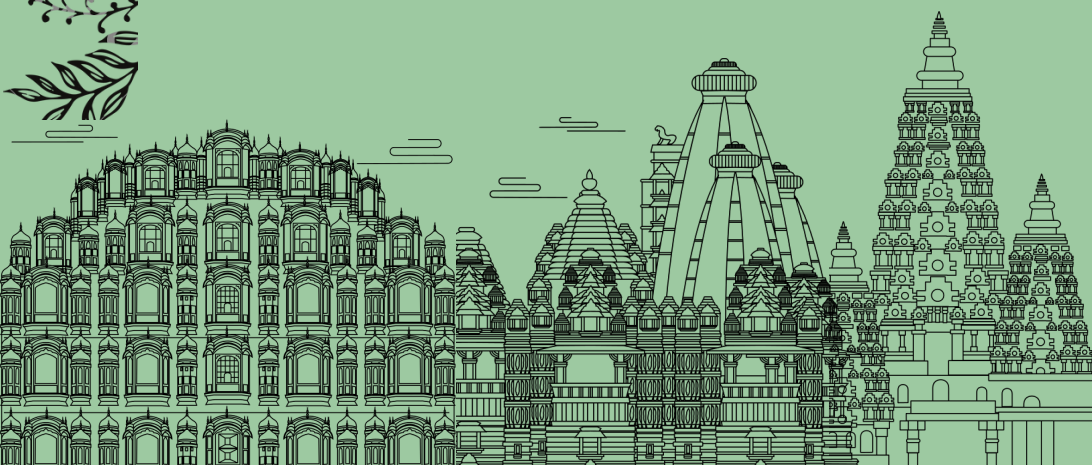



**C. Adarsh, attended webinar on " Construction Issues In Precast Structural Systems ", conducted by Crete Concrete Pvt. Ltd on DATE: March 28, 2023**

**C. Adarsh, attended a Quiz Competition event in BLITZKRIEG 2023, conducted by MIT Anna university Chennai on DATE : 22 April 2023**  
**N. Annamalai has completed an online course "Learning AutoCad" on 08/04/2023.**

**Nishta M N has won First Place in Chamber of Secrets (Treasure Hunt) - ICI Fest - 25th April 2023.**

**Srinidhi Seran has won the first place in ICI Fest Chamber of secrets (treasure hunt).**

**S. Dakshetha has won in ICI quiz -- ICI Fest - 25th April 2023.**  
**Elanthalir A of II year has completed the learning excel online (Microsoft 365) during April 2023.**

**C. Adarsh has participated in the Research paper presentation Event in ICI FEST 2023, SSN college of engineering Conducted on 25.04.2023 by SSN-ICI Student Chapter**

**C. Adarsh has participated in the event Code wizard Event in ICI FEST 2023, SSN college of engineering and won 2nd place in the Event Conducted on 25.04.2023 by SSN-ICI Student Chapter**

**C. Adarsh attended webinar on "Building products for Building Construction " conducted by Ultratech Pvt. Ltd. On Date: 29.04.2023.**

**C. Adarsh attended webinar on " Case Studies on rehabilitation measures on bridges " conducted by Ultratech Pvt. Ltd. On Date : 6.05.2023**

**C. Adarsh attended webinar on "Box Jacking with Soil Nailing for construction of roads/underpass " conducted by Ultratech Pvt. Ltd. On Date :13.05.2023**

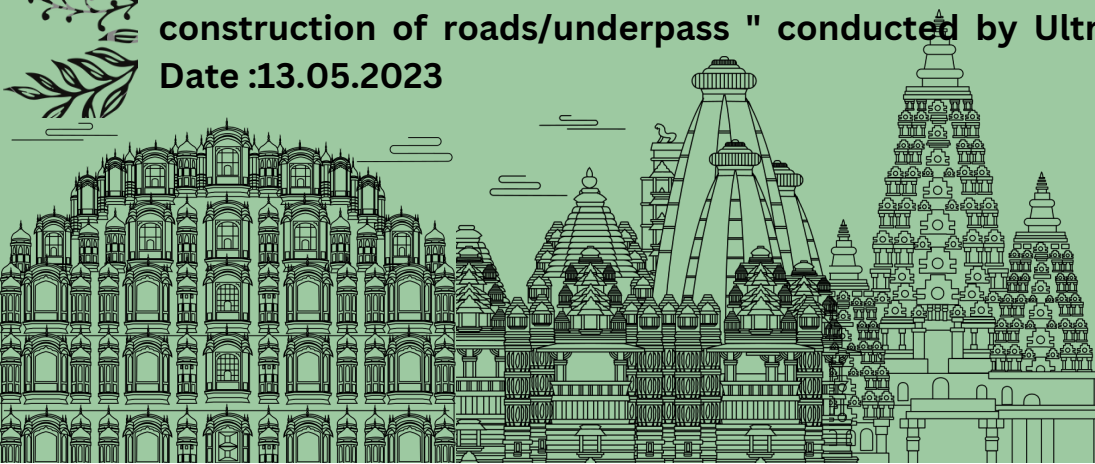

C.Adarsh attended webinar on " Remaining Life analysis for an uninterrupted structural performance " conducted by Ultratech Pvt. ltd. On Date :20.05.2023.

Elanthalir A of II year completed the certification in strategies for sustainable Design by 25/05/2023.

K.Govindaraj has participated in the Chamber of Secrets conducted by ICI Fest 23, organized by SSN ICI Student Chapter on 25th April 2023.

## 11.2 Student Extra-Curricular Activities

Prashant S, III yr has completed Dance competition in Bangalore (Battle yaa skills, PES University, kristu jayanti college), held on April 2023.

Prashant S, III yr has participated Dance competition in Chennai (MIT, ACTech, Gurunanak , Ethiraj , CIT, Alpha college) on 17th April 2023.

Prashant S, III yr has secured a runner up position in Alagappa college of technology during 16th and 17th of April 2023.

Prashant S, III yr has participated in Choreo Night in Chennai Institute of Technology (dance competition) on 30th,31st,1st of April 2023.

Kaviya Roshne GM has participated in Choreo Night in Chennai Institute of Technology (dance competition) on 30th,31st,1st of April 2023.

Kaviya Roshne GM has secured III place in Gurunanak (dance competition) during 17th of March 2023.

Kaviya Roshne GM has won first place in Group dance conducted in Alpha college of engineering (dance competition) during 20 and 21st March 2023.



**Kaviya Roshne GM has secured a runner up position in Alagappa college of technology during 16th and 17th of April 2023.**

**Kaviya Roshne GM has participated and won in Battle ya skills Bangalore held on April 2023.**

**Ravi Raam has participated in Handball Inter year first place on 30/03/2023.**

**Ravi Raam has participated in Kho-Kho Inter year second place on 10/04/2023**

## **12. NON-TEACHING STAFF ACTIVITY**

**Prasath R has attended Online Webinar on “Water Audit” held on 3rd December 2022 organized by Ultratech Cement Limited.**

**K Jegadheesan has attended Online course titled 'Advance Diploma in Environmental and Geomechanics' for a period of attended during 28th December 2022, through ALISON.**

**Aravindh.S has attended Workshop on 'Current Trends in Civil Engineering Research' held on 15th February 2023 organized by Dept. of Civil Engineering, SSN College of Engineering, Chennai.**

**S. Aravindh has attended Workshop on 'Measurement possibilities using microwave analyzer' held on 29th April 2023 organized by Dept. of Electronics and communication Engineering, SSN College of Engineering, Chennai.**

**S. Aravindh has attended an Online Webinar on 'Building Products for Building Solutions' held on 29th Apr 2023, organized by Ultra Tech Cement Ltd.**

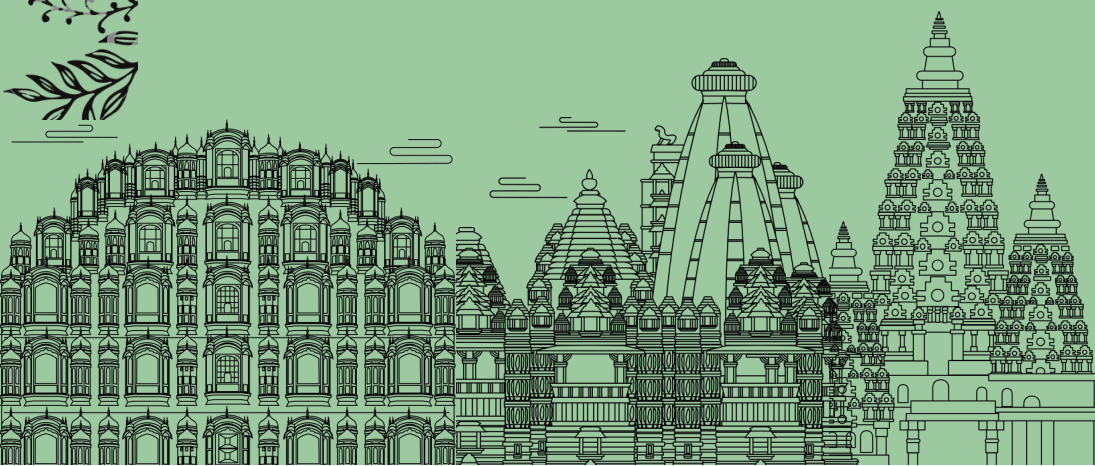

**S. Aravindh has attended Online Webinar on 'Case Studies on Rehabilitation Measures for Bridges ' held on 6th May 2023, organized by Ultra Tech Cement Ltd.**

**S. Aravindh has attended Online Webinar on 'Box Jacking with Soil Nailing for Construction of Rail/Road Underpass' held on 13th May 2023, organized by Ultra Tech Cement Ltd.**

**S. Aravindh has attended an Online Webinar on 'Remaining Life Analysis for An Uninterrupted Structural Performance' held on 20th May 2023, organized by Ultra Tech Cement Ltd.**

**Aravindh.S has attended Online webinar on 'Health monitoring of structures through instrumentation 'held on 11th February 2023, Organized by Ultratech Cement Ltd, Chennai.**

**Aravindh.S has attended Workshop on 'Current Trends in Civil Engineering Research' held on 15th February 2023 organized by Dept. of Civil Engineering, SSN College of Engineering, Chennai.**

**Aravindh.S has attended Online webinar on 'Health monitoring of structures through instrumentation 'held on 11th February 2023, Organized by Ultratech Cement Ltd, Chennai.**

**S.Aravindh has attended Online Webinar on 'Health Monitoring of Concrete Structure' held on 22th Apr 2023, organized by Ultra Tech Cement Ltd.**

**S.Aravindh has attended Online Webinar on 'High Strength Fiber Reinforced Concrete - Its Behavior and Application' held on 15th Apr 2023, organized by Ultra Tech Cement Ltd.**

**S.Aravindh has attended Online Webinar on 'Common Causes of Distresses in the Concrete Bridges' held on 8th Apr 2023, organized by Ultra Tech Cement Ltd.**

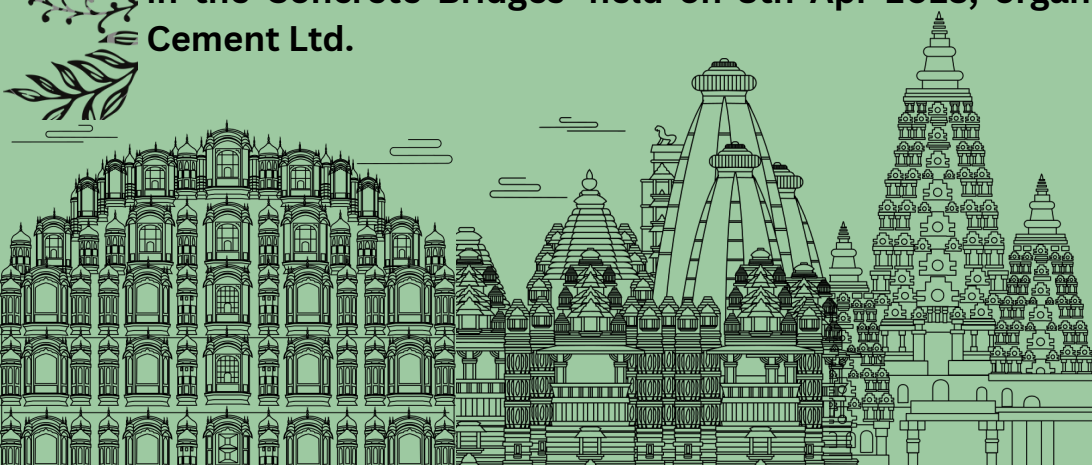



**Balaji.M has attended Online webinar on 'Health monitoring of structures through instrumentation 'held on 11th February 2023, Organized by Ultratech Cement Ltd, Chennai.**

**Balaji.M has attended Online webinar on 'Health monitoring of structures through instrumentation 'held on 11th February 2023, Organized by Ultratech Cement Ltd, Chennai.**

**Balaji.M has attended Workshop on 'Current trends in Civil Engineering Research' held on 15th February 2023 organized by Dept. of Civil Engineering, SSN College of Engineering, Chennai.**

**Balaji.M has attended Workshop on 'Current trends in Civil Engineering Research' held on 15th February 2023 organized by Dept. of Civil Engineering, SSN College of Engineering, Chennai.**

**M. Balaji has attended an Online Webinar on 'Innovation Precasting Techniques in Signature Bridge, Delhi' held on 1st Apr 2023, organized by Ultra Tech Cement Ltd.**

**M. Balaji has attended an Online Webinar on 'Common Causes of Distresses in the Concrete Bridges' held on 8th Apr 2023, organized by Ultra Tech Cement Ltd.**

**M. Balaji has attended an online Webinar on 'High Strength Fiber Reinforced Concrete - Its Behavior and Application' held on 15th Apr 2023, organized by Ultra Tech Cement Ltd.**

**M. Balaji has attended an online Webinar on 'Health Monitoring of Concrete Structure' held on 22th Apr 2023, organized by Ultra Tech Cement Ltd.**

**Balaji M has attended Workshop on 'Measurement possibilities using microwave analyzer' held on 29th April 2023 organized by Dept. of Electronics and communication Engineering, SSN College of Engineering, Chennai.**

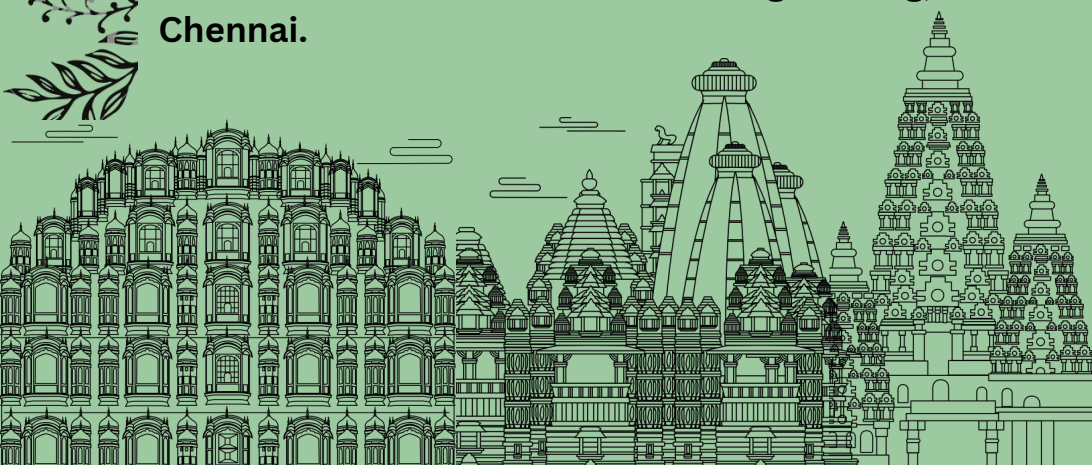



**Balaji M has attended Online Webinar on 'Building Products for Building Solutions' held on 29th Apr 2023, organized by Ultra Tech Cement Ltd.**

**Balaji M has attended an Online Webinar on 'Case Studies on Rehabilitation Measures for Bridges ' held on 6th May 2023, organized by Ultra Tech Cement Ltd.**

**Balaji M has attended an Online Webinar on 'Box Jacking with Soil Nailing for Construction of Rail/Road Underpass' held on 13th May 2023, organized by Ultra Tech Cement Ltd.**

**Balaji M has attended Online Webinar on 'Remaining Life Analysis for An Uninterrupted Structural Performance' held on 20th May 2023, organized by Ultra Tech Cement Ltd.**

**Princely. K has attended Workshop on 'Current Trends in Civil Engineering Research' held on 15th February 2023 organized by Dept of civil Engineering, SSN College of Engineering, Chennai.**

**Princely. K has attended Workshop on 'Current Trends in Civil Engineering Research' held on 15th February 2023 organized by Dept of civil Engineering, SSN College of Engineering, Chennai.**

**K. Princely has attended Online Webinar on 'Innovation Precasting Techniques in Signature Bridge, Delhi' held on 1th Apr 2023, organized by Ultra Tech Cement Ltd.**

**K. Princely has attended Online Webinar on 'Common Causes of Distresses in the Concrete Bridges' held on 8th Apr 2023, organized by Ultra Tech Cement Ltd.**

**K. Princely has attended Online Webinar on 'High Strength Fiber Reinforced Concrete - Its Behavior and Application' held on 15th Apr 2023, organized by Ultra Tech Cement Ltd.**

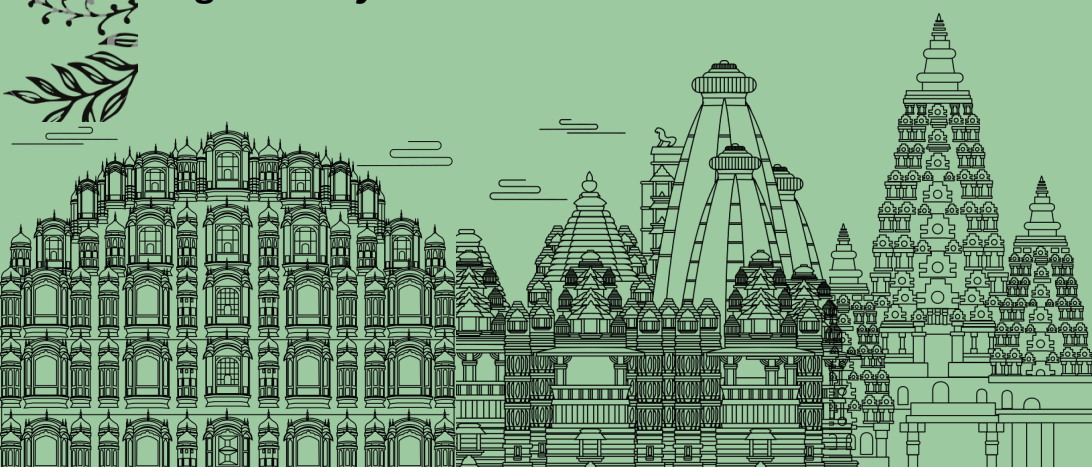



**K. Princely has attended Online Webinar on 'Health Monitoring of Concrete Structure' held on 22th Apr 2023, organized by Ultra Tech Cement Ltd.**

**K. Princely has attended Workshop on 'Measurement possibilities using microwave analyzer' held on 29th April 2023 organized by Dept. of Electronics and communication Engineering, SSN College of Engineering, Chennai**

**K. Princely has attended Online Webinar on 'Building Products for Building Solutions' held on 29th Apr 2023, organized by Ultra Tech Cement Ltd.**

**K. Princely has attended Online Webinar on 'Case Studies on Rehabilitation Measures for Bridges ' held on 6th May 2023, organized by Ultra Tech Cement Ltd.**

**K. Princely has attended Online Webinar on 'Box Jacking with Soil Nailing for Construction of Rail/Road Underpass' held on 13th May 2023, organized by Ultra Tech Cement Ltd.**

**K. Princely has attended Online Webinar on 'Remaining Life Analysis for An Uninterrupted Structural Performance' held on 20th May 2023, organized by Ultra Tech Cement Ltd.**

**Parthiban C has attended an Online webinar on ' Health monitoring of structure through instrumentation' held on 11th February 2023 organized by Ultratech cement Ltd, Chennai.**

**Parthiban C has attended Workshop on ' Current Trends in Civil Engineering Research' held on 15th February 2023 organized by Dept of civil Engineering, SSN College of Engineering, Chennai.**

**Parthiban C has attended an Online webinar on ' Health monitoring of structure through instrumentation' held on 11th February 2023 organized by Ultratech cement Ltd, Chennai.**

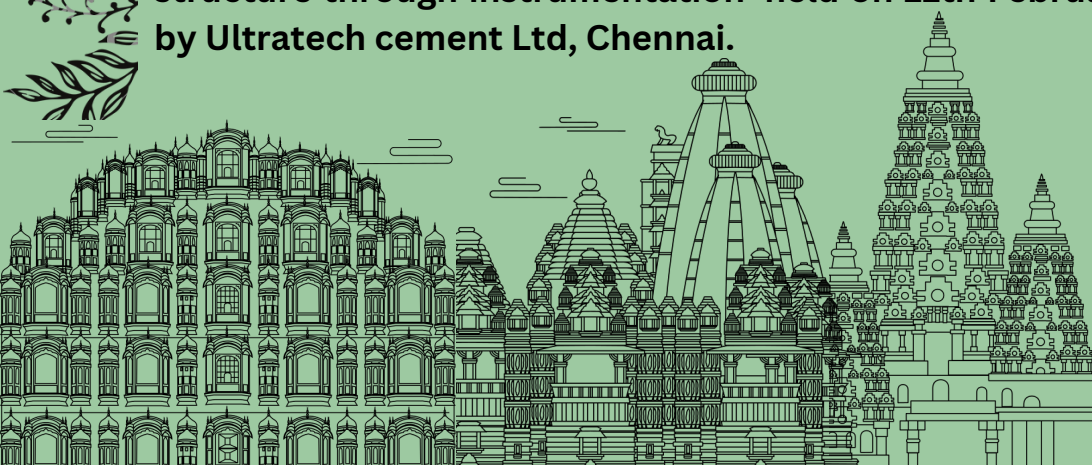



**Parthiban C has attended Workshop on ' Current Trends in Civil Engineering Research' held on 15th February 2023 organized by Dept of civil Engineering, SSN College of Engineering, Chennai.**

**C. Parthiban has attended Online Webinar on 'Innovation Pre-casting Techniques in Signature Bridge, Delhi' held on 1th Apr 2023, organized by Ultra Tech Cement Ltd.**

**C. Parthiban has attended Online Webinar on 'Common Causes of Distresses in the Concrete Bridges' held on 8th Apr 2023, organized by Ultra Tech Cement Ltd.**

**C. Parthiban has attended Online Webinar on 'High Strength Fiber Reinforced Concrete - Its Behaviour and Application' held on 15th Apr 2023, organized by Ultra Tech Cement Ltd.**

**C. Parthiban has attended Online Webinar on 'Health Monitoring of Concrete Structure' held on 22th Apr 2023, organized by Ultra Tech Cement Ltd.**

**Parthiban has attended Workshop on 'Measurement possibilities using microwave analyzer' held on 29th April 2023 organized by Dept. of Electronics and communication Engineering, SSN College of Engineering, Chennai.**

**Parthiban has attended Online Webinar on 'Case Studies on Rehabilitation Measures for Bridges ' held on 6th May 2023, organized by Ultra Tech Cement Ltd.**

**Parthiban has attended Online Webinar on 'Box Jacking with Soil Nailing for Construction of Rail/Road Underpass' held on 13th May 2023, organized by Ultra Tech Cement Ltd.**

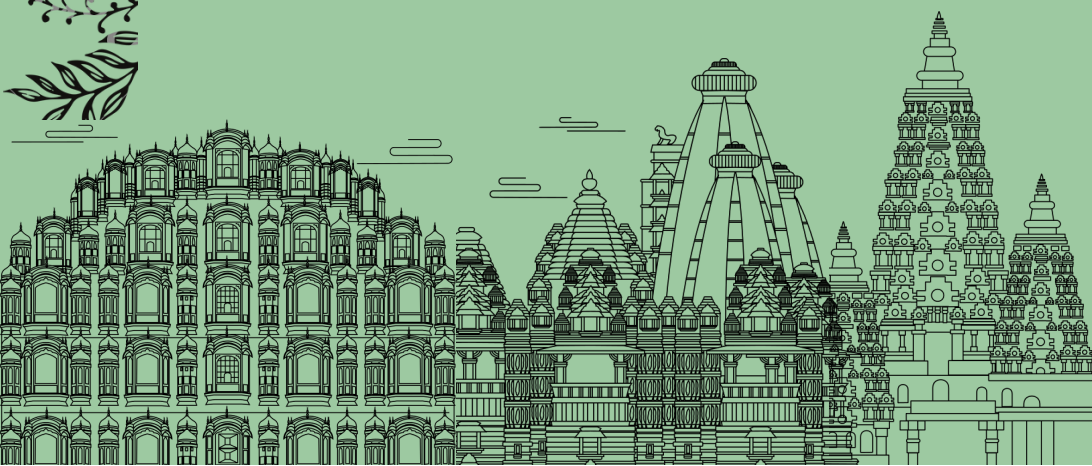

Deborah G has completed an Online Certified course titled "Executive Assistant Skills", for a period of "16 hours" attended from 13th February till 18th February 2023 through Alison online course.

Deborah G has completed an Online Certified course titled "Executive Assistant Skills", for a period of "16 hours" attended from 13th February till 18th February 2023 through Alison online course.

G. Deborah has attended the Online Webinar on 'Box Jacking with Soil Nailing for Construction of Rail/Road Underpass' held on 13th May 2023, organized by Ultra Tech Cement Ltd.

### 13. FAREWELL

A farewell has been organized to "Final year" Civil Engineering Students on "12.05.2023" at "Department Seminar Hall". There was a Chit Chat Session between students and Faculty. The students were greeted for their success futures and endeavours.



Informal Photo Session of Batch 2019-2023-Fare Well



Farewell to Dr.Jijo James Associate Professor was conducted on 1-6-2023. Dr.Jijo James has more than 15 years of experience in teaching. He was in SSN Family for the past 5 years in Civil Engineering Department and at second innings he moved to Anna University as Assistant Professor in Civil Engineering. We wish him all the best for his feature Endeavors.



## 14. ARTICLES

### 14.1 STUDENTS ARTICLES

#### Geo-Spatial Technologies in Civil Engineering Akash ABM IV Year Civil Engineering

ARCGIS software is mainly used for geographic information system. I have used this software in my final year projects like Design of percolation pond and identifying ground water potential zone by analytical hierarchy process (AHP), Demarcation of Groundwater Potential and Recharge Zone using Electrical Resistivity Survey. This project is planning for implementing in SSN College of Engineering. For this project I have used ARCGIS software.



ARCGIS helps in many ways to find isotropic characteristics, Ground Water Potential Map, GIS Map creation, DEM Data, Rainfall data, soil map, drainage density map, lineament map, lithology map, slope map LULC MAP and goes on like that we can find many things for e.g.:

If you want to find for particular place, we can do in ARCGIS Software for that we have to take what place we need in Google earth map and import in the ARCGIS Software and if you want to find isotropic characteristics of that specific place, we need to collect water sample from that places and test the samples and get the reading and import in the ARCGIS Software and then you will get the isotropic characteristics map like (pH, H<sub>2</sub>O). Nowadays ARCGIS Software are mostly and widely used in many ways.

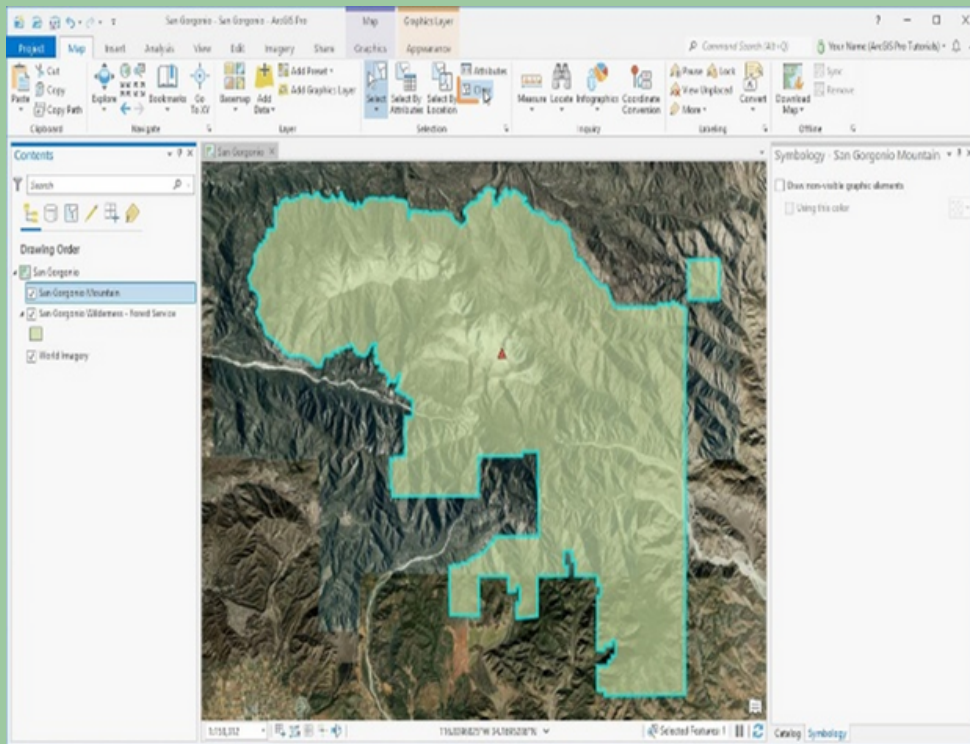

**Latest Innovations in Science and Technology**  
**Ashwin Kumar KT IV Year Civil Engineering**



## Three-Dimensional Printing

Max Bogue and Peter Dilworth created a pen that draws in the air. A multi-coloured spool of plastic thread is fed into the pen. The thread is then extruded as heated plastic that cools and solidifies quickly as it exits the tip. This permits solid 3D constructions to be drawn on any surface or from any surface into the air. The 3Doodler pen weighs about 7 ounces (198 g) and measures 7 inches (17.7 cm) long. It requires no technological skills or software and just plugs into an electrical socket. Max and Peter have received over 2.2 million dollars in advance orders for their three-dimensional printing pen. They plan to fulfill those orders and debut the product in the fall of this year. The co-inventors met while working for WowWee, a company based in Hong Kong that develops consumer technologies.

## Glass Nanobots Absorb Toxins

A glass nanobot particle that may absorb pollutants from contaminated water is being created.

The glass particles function as sponges, collecting and binding pollutants to themselves while swelling eight times their size. However, unlike sponges, these nanobots are hydrophobic, which means they do not absorb water. According to scientists, this new technology might be used to clean up petroleum spills and other harmful pollutants in our rivers. When the particles are put into the water, they gather impurities and, when completely inflated, rise to the surface. The particles are then skimmed from the surface, cleaned, and returned to the water, where the procedure is repeated.

## Water Drop Lens

Bruno Berge, a physicist, and inventor, has developed a liquid optical lens. A water drop is deposited on a metal substrate and coated by a thin insulating layer using the electro-wetting method. When a voltage is supplied to the metal, the angle of the liquid drop changes. The liquid lens is made up of two liquids: water and oil, one of which is a conductor and the other an insulator.

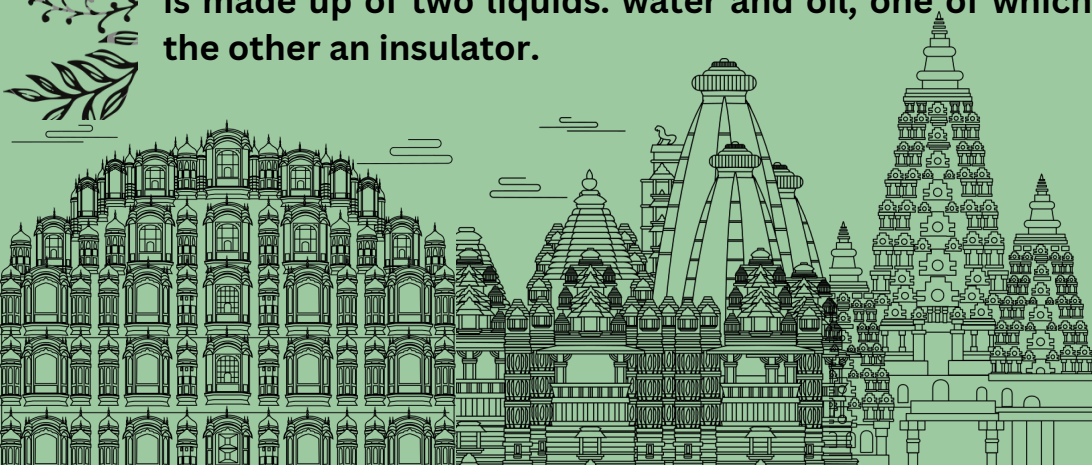

A change in voltage affects the curvature of the liquid-liquid contact, which changes the focal length of the lens. The use of liquids enables low-cost building. There are no moving parts, and the electricity used is incredibly minimal. The lens enables wide inverted focal length range and rapid focus.

## Latest Software Development in Civil Engineering

### J. Jemimah, 3rd YR CIVIL

Technology is impacting the construction industry like never before. From cloud-based collaboration and the development of digital twins to robots, super-materials, wearable tech, pollution-eating buildings, and even artificial intelligence, an incredible array of actions is helping to improve a sector that shapes how every human being on Earth can live their lives.



### KNOWIFY

Knowify is a cloud-based construction management solution that is designed for residential contractors and small to midsize commercial subcontractors. It is suitable for trades, including landscaping, roofing, and masonry.

Knowify helps in managing different administrative tasks including job estimation and bidding, contract management and change orders.



Users can create contract and bid for them as well as send documents electronically for digital signatures. With time tracking and scheduling feature, administrators can keep track of staff check-in and check-out time.

The logo for 'knowify' is displayed in a white rectangular box. The word 'knowify' is written in a lowercase, sans-serif font. The letter 'o' is highlighted in orange and features a stylized sunburst or crown-like shape above it. The remaining letters 'k', 'n', 'w', 'i', 'f', and 'y' are in a grey color.

## Estimator360

Estimator360 is Cloud-Based Construction Estimating & Management Software for Builders. Estimator360 is a cloud/online based software solution for construction estimating and management, which includes a comprehensive catalogue of pre-package unit cost assemblies, real-time supplier costs, client/customer interaction, contracts, change orders, automated scheduling, time sheets, dashboards, reporting, and accounting.

Estimator360 integrated with management software seamlessly transitions your estimates and proposals to active projects. It Automatically generate schedules and purchase orders, monitor crew activity, and keep suppliers and clients informed with real-time data.

With cloud-based estimating software, we can easily manage our estimates from anywhere on any device.

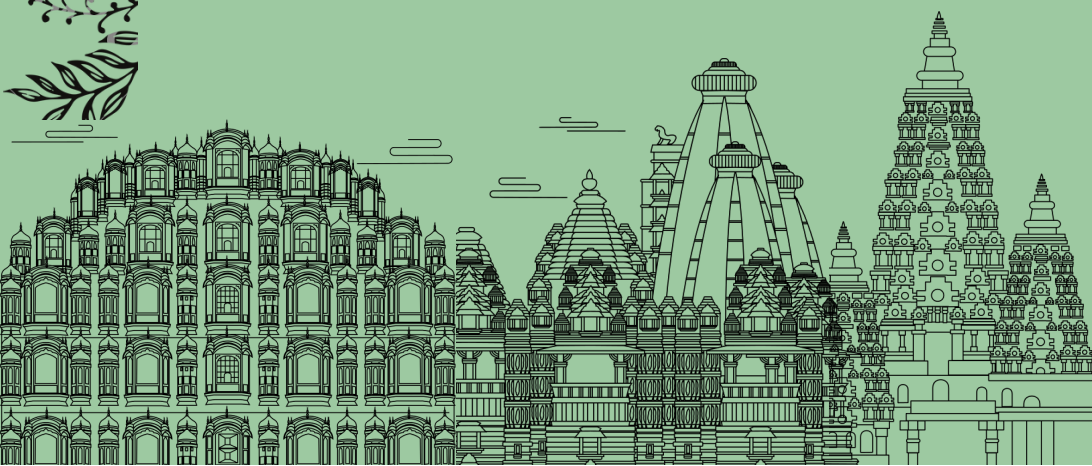



Estimator360

# Construction Estimating & Management Software

ESTIMATOR360

PLAXIS Monopile Designer CONNECT Edition is the most advanced application for designing monopile foundations. With PLAXIS Monopile Designer, you can significantly optimize the designs for your monopile foundation project and lower steel, fabrication, transportation, and installation costs.

PLAXIS Monopile Designer uses the most advanced and innovative method for designing laterally loaded monopiles - The Pile Soil Analysis (PISA). This method is the industry's best practice for developing current and future generation offshore wind farms.

Through it, PLAXIS Monopile Designer addresses many of the shortcomings of other design methods for construction in the offshore wind turbine sector.

PLAXIS Monopile Designer is fully interoperable with PLAXIS 3D and can be used either as a stand-alone application when defining the soil reaction curves (rule-based design) or with the most advanced and widely used geotechnical software solution when extracting them numerically from 3D FEM models (numerical-based design).

Working together, PLAXIS Monopile Designer and PLAXIS 3D easily automate the process of generating and calculating 3D models, deriving, normalizing, and parameterizing soil reaction curves, and extracting them to the 1D model.

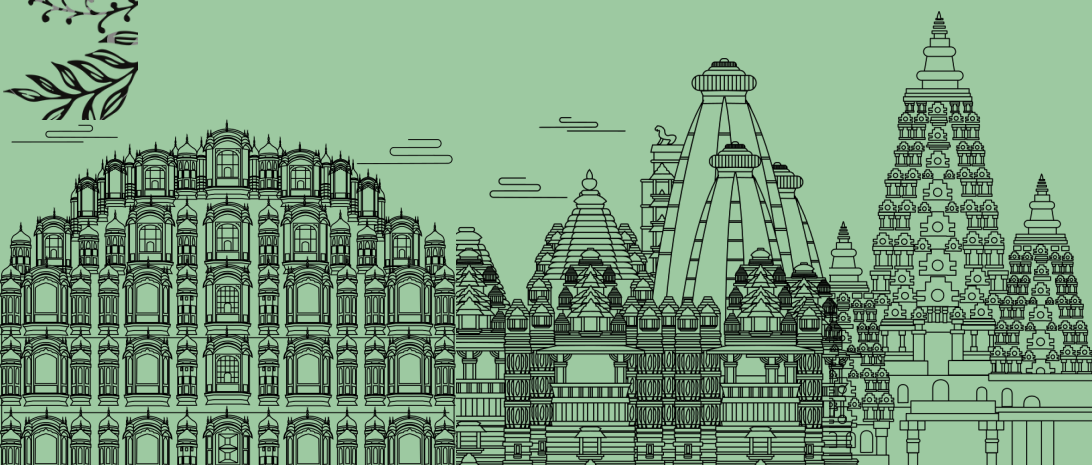

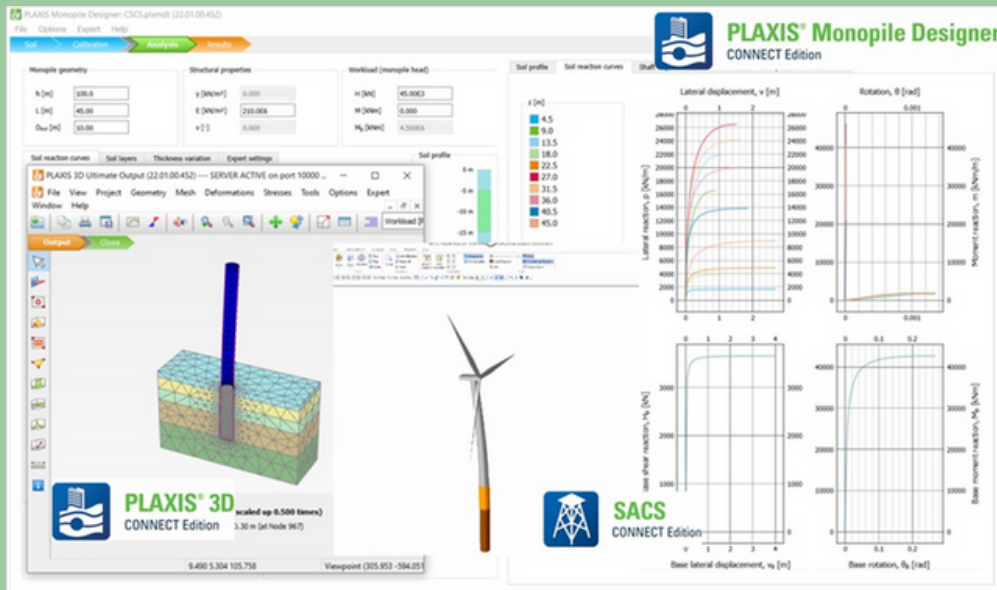

## Modular Construction: Revolutionizing Civil Engineering

### B.Yogesh, Third Year, Civil Engineering Department

In the field of civil engineering, modular construction has changed the game by providing many benefits over conventional construction techniques. This cutting-edge method entails producing individual parts or modules in a controlled manufacturing setting before transporting them to the construction site for assembly. This article examines the idea of modular building, stressing its advantages, uses, and effects on the discipline of civil engineering.

The idea behind modular construction is to create buildings out of off-site-produced, prefabricated modules. These modules are built in a factory-controlled setting, guaranteeing consistency in quality and accuracy. The modules can be anything from straightforward floor cassettes and wall panels to whole volumetric units with fitted rooms. The final construction is created by assembling these components after they have been carried to the location.



The substantial reduction in building time is one of the main benefits of modular construction. Project timelines can be significantly lowered because the modules are created concurrently with site preparation and foundation work. Additionally, the controlled industrial environment reduces delays brought on by bad weather and permits concurrent construction activities, increasing total efficiency.

There are several ways that modular construction might save costs. A more efficient use of resources is made possible by the streamlined manufacturing process and the controlled environment. Off-site fabrication also lowers labor expenses because jobs may be completed more quickly in a facility. Additionally, the reduced financing and site management costs result from the shorter building period.

High-quality standards are guaranteed by the factory-controlled environment of modular construction. Construction quality is continually higher thanks to the use of precision machinery, standardized procedures, and strict quality controls. Further improving the overall quality of the finished product is the controlled environment's elimination of on-site variables like weather and human error.

By reducing material waste and maximizing energy use, modular building encourages sustainability. Utilizing resources efficiently during the manufacturing process, extra materials are recycled or used for new purposes. Additionally, the shorter building period and site disruption lessen environmental effects including noise pollution and ecosystem disturbance. Due to its efficacy and affordability, modular construction has grown in favor in the residential sector. The quicker building periods and higher level of quality control provided by modular construction are advantageous for single-family homes, apartments, and student housing projects.

Infrastructure projects like bridges, tunnels, and even complete modular housing communities are increasingly employing modular construction. Prefabricated parts enable quick deployment, minimizing disturbances to communities and traffic.

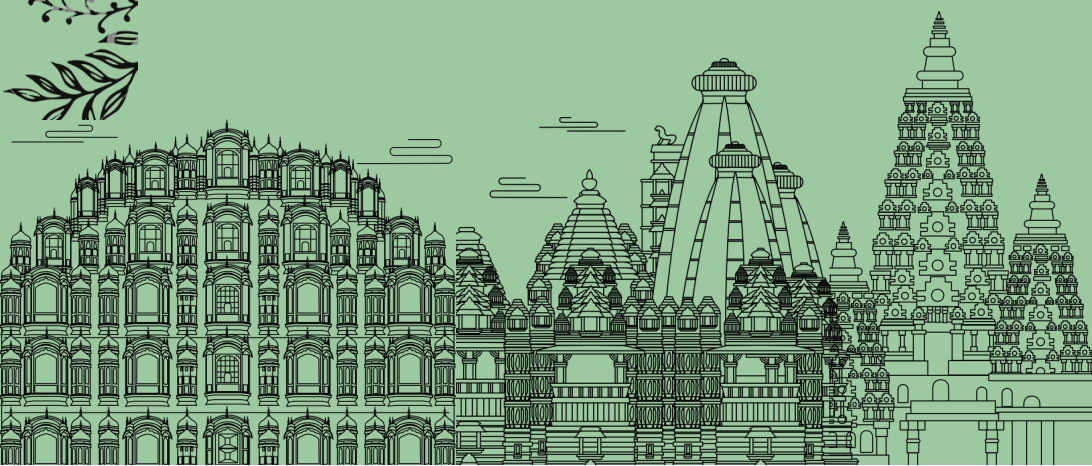

The use of modular construction as a quicker, more affordable, and environmentally friendly alternative to conventional construction techniques has revolutionized the area of civil engineering. Modular construction is ready to change the industry with its many benefits, including time and money savings, improved quality control, and environmental benefits. Future construction projects are anticipated to incorporate modular construction more and more as technical developments continue to improve the method.



A 2 Storey building completed using modular construction method.

## Microplastics

### GS Saarusha II Year Civil Engineering

Microplastics are tiny plastic particles that result from both commercial product development and the breakdown of larger plastics. As a pollutant, microplastics can be harmful to the environment and animal health.

Living organisms tangled in microplastics. A sample of water collected off the coast of Hawaii shows how intertwined microplastics are in the daily lives of marine animals.

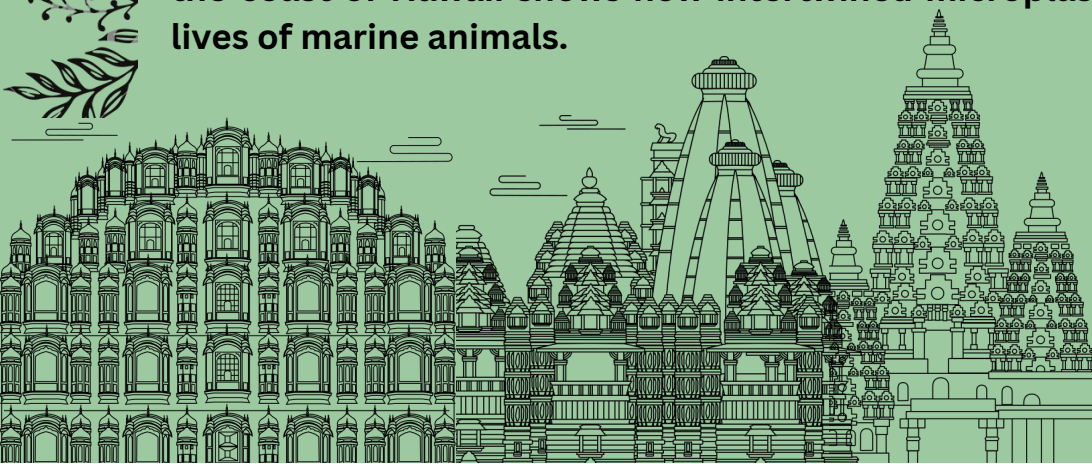





**Microplastics, as the name implies, are tiny plastic particles. Officially, they are defined as plastics less than five millimeters (0.2 inches) in diameter—smaller in diameter than the standard pearl used in jewelry. There are two categories of microplastics: primary and secondary.**

**Primary microplastics are tiny particles designed for commercial use, such as cosmetics, as well as microfibers shed from clothing and other textiles, such as fishing nets. Secondary microplastics are particles that result from the breakdown of larger plastic items, such as water bottles. This breakdown is caused by exposure to environmental factors, mainly the sun's radiation and ocean waves.**

**The problem with microplastics is that—like plastic items of any size—they do not readily break down into harmless molecules. Plastics can take hundreds or thousands of years to decompose—and in the meantime, wreak havoc on the environment. On beaches, microplastics are visible as tiny multicolored plastic bits in sand. In the oceans, microplastic pollution is often consumed by marine animals.**

**Some of this environmental pollution is from littering, but much is the result of storms, water runoff, and winds that carry plastic—both intact objects and microplastics—into our oceans. Single-use plastics—plastic items meant to be used just once and then discarded, such as a straw—are the primary source of secondary plastics in the environment.**



Scientists are still unsure whether consumed microplastics are harmful to human or animal health—and if so, what specific dangers they may pose. Even so, many countries are taking action to reduce microplastics in the environment. A 2017 United Nations resolution discussed microplastics and the need for regulations to reduce this hazard to our oceans, their wildlife, and human health.

### Biological integration into organisms

Microplastics can become embedded in animals' tissue through ingestion or respiration. Various annelid species, such as deposit-feeding lugworms (*Arenicola marina*), have been shown to have microplastics embedded in their gastrointestinal tracts. Many crustaceans, like the shore crab *Carcinus maenas*, have been seen to integrate microplastics into both their respiratory and digestive tracts. Plastic particles are often mistaken by fish for food which can block their digestive tracts sending incorrect feeding signals to the brains of the animals. New research revealed, however, that fish ingest microplastics inadvertently rather than intentionally.

Some coral such as *Pocillopora verrucosa* have also been found to ingest microplastics. It can take up to 14 days for microplastics to pass through an animal (as compared to a normal digestion period of 2 days), but entanglement of the particles in animals' gills can prevent elimination entirely. When microplastic-laden animals are consumed by predators, the microplastics are then incorporated into the bodies of higher trophic-level feeders. For example, scientists have reported plastic accumulation in the stomachs of lantern fish which are small filter feeders and are the main prey for commercial fish like tuna and swordfish. Microplastics also absorb chemical pollutants that can be transferred into the organism's tissues. Small animals are at risk of reduced food intake due to false satiation and resulting starvation or other physical harm from the microplastics.

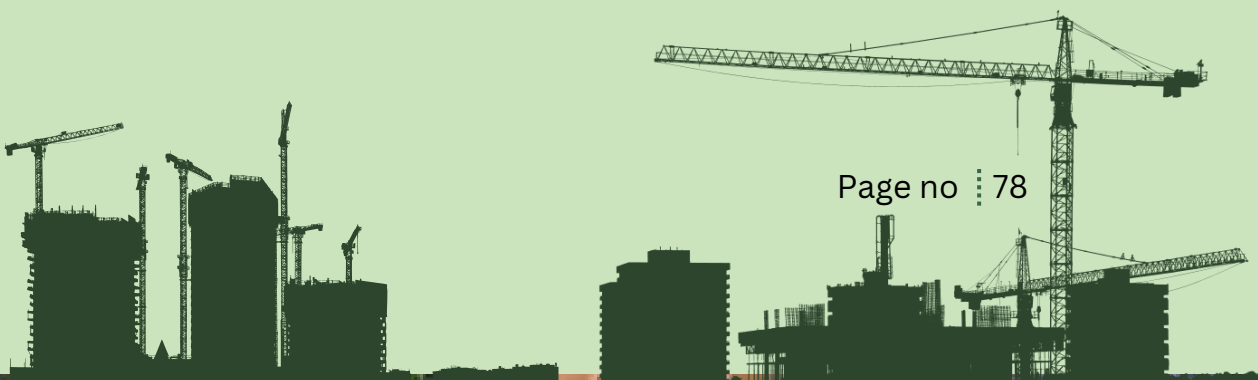

A study done at the Argentinean coastline of the Rio de la Plata estuary, found the presence of microplastics in the guts of 11 species of coastal freshwater fish. These 11 species of fish represented four different feeding habits: detritivore, planktivore, omnivore and ichthyophagous. This study is one of the few so far to show the ingestion of microplastics by freshwater organisms.

Bottom feeders, such as benthic sea cucumbers, who are non-selective scavengers that feed on debris on the ocean floor, ingest large amounts of sediment. It has been shown that four species of sea cucumber (*Thyonella gemmate*, *Holothuria floridana*, *H. grisea* and *Cucumaria frondosa*) ingested between 2- and 20-fold more PVC fragments and between 2- and 138-fold more nylon line fragments (as much as 517 fibers per organism) based on plastic-to-sand grain ratios from each sediment treatment. These results suggest that individuals may be selectively ingesting plastic particles. This contradicts the accepted indiscriminate feeding strategy of sea cucumbers and may occur in all presumed non-selective feeders when presented with microplastics.

### Microplastic Invasion: Air

Airborne microplastics have been detected in the atmosphere, as well as indoors and outdoors. In 2019 a study found microplastic to be atmospherically transported to remote areas on the wind. A 2017 study found indoor airborne microfiber concentrations between 1.0 and 60.0 microfibers per cubic meter (33% of which were found to be microplastics). Another study looked at microplastic in the street dust of Tehran and found 2,649 particles of microplastic within 10 samples of street dust, with ranging samples concentrations from 83 particle – 605 particles ( $\pm 10$ ) per 30.0 g of street dust. Microplastics and microfibers were also found in snow samples, and high up in "clean" air in high mountains at vast distances from their source. However, much like freshwater ecosystems and soil, more studies are needed to understand the full impact and significance of airborne microplastics.

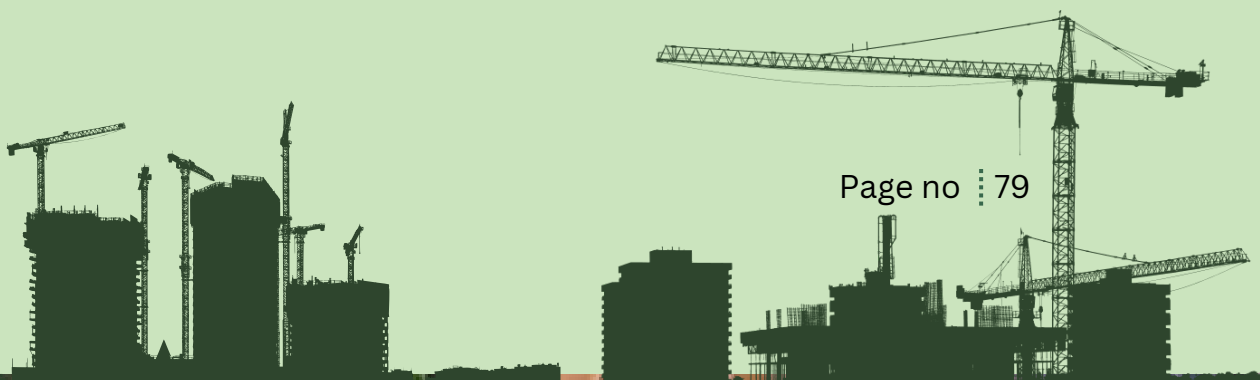

## Water

A growing concern regarding plastic pollution in the marine ecosystem is the use of microplastics. Microplastics are beads of plastic less than 5 millimeters wide, and they are commonly found in hand soaps, face cleansers, and other exfoliators. When these products are used, the microplastics go through the water filtration system and into the ocean, but because of their small size they are likely to escape capture by the preliminary treatment screens on wastewater plants. These beads are harmful to the organisms in the ocean, especially filter feeders, because they can easily ingest the plastic and become sick. The microplastics are such a concern because it is difficult to clean them up due to their size, so humans can try to avoid using these harmful plastics by purchasing products that use environmentally safe exfoliates. Because plastic is so widely used across the planet, microplastics have become widespread in the marine environment. For example, microplastics can be found on sandy beaches and surface waters as well as in the water column and deep in sea sediment. Microplastics are also found within the many other types of marine particles such as dead biological material (tissue and shells) and some soil particles (blown in by wind and carried to the ocean by rivers). Population density and proximity to urban centers have been considered the main factors that influence the abundance of microplastics in the environment.

## Soil

A substantial portion of microplastics is expected to end up in the world's soil, yet very little research has been conducted on microplastics in soil outside of aquatic environments. In wetland environments microplastic concentrations have been found to exhibit a negative correlation with vegetation cover and stem density. There exists some speculation that fibrous secondary microplastics from washing machines could end up in soil through the failure of water treatment plants to completely filter out all of the microplastic fibers. Furthermore, geophagous soil fauna, such as earthworms, mites, and collembolans could contribute to the amount of secondary microplastic present in soil by converting consumed plastic debris into microplastic via digestive processes. Further research, however, is needed.

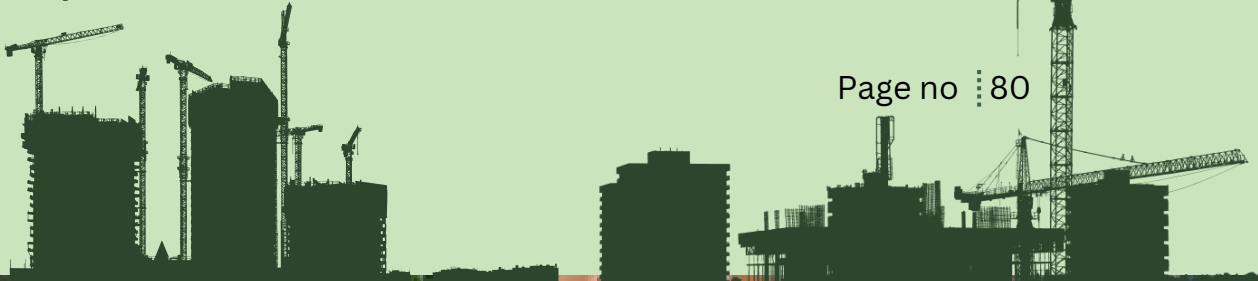

There is concrete data linking the use of organic waste materials to synthetic fibers being found in the soil; but most studies on plastics in soil merely report its presence and do not mention origin or quantity. Controlled studies on fiber-containing land-applied wastewater sludges (biosolids) applied to soil reported semiquantitative recoveries of the fibers several years after application.

## Human body

Microplastics find their way into the food we eat, the water we drink and even the air we breathe. By some estimates, people consume more than 50,000 plastic particles per year – and many more if inhalation is considered.

Microplastics were found in every human tissue studied by graduate students at Arizona State University. A study published in March 2022 revealed that microplastics have also been found in 80% of 22 anonymous blood samples, meaning they can be transported around the human body and raising the question of whether they can be transported to the brain. According to research conducted by the Medical University of Vienna, five grams of plastic particles enter each person's gastrointestinal stream on average per week. This is approximately the weight of a credit card. According to another recent estimate, a person who consumes seafood will ingest 11,000 bits of microplastics per year. Even very minute microplastics have been discovered in human blood. Microplastics have been discovered in food in recent investigations. A recent study found a kilo of sugar had 440 microplastics, a kilo of salt contained 110 microplastics, and a litre of bottled water contained 90 microplastics. It is high time that we should take action against microplastic pollution before it turns out to be a havoc for living organisms.

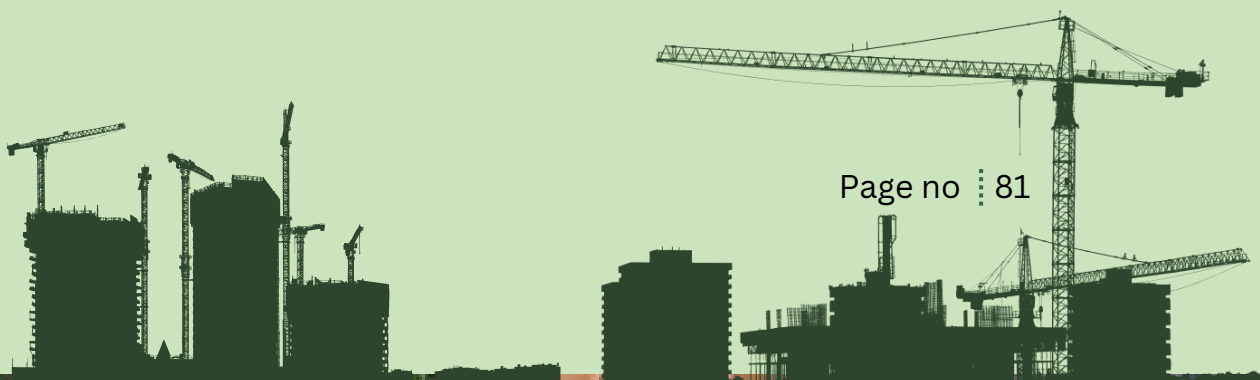

# Climate Change

## Nishta MN II year Civil Engineering



Climate change is a long-term shift in global or regional climate patterns. Often climate change refers specifically to the rise in global temperatures from the mid-20th century to present.

Climate is sometimes mistaken for weather. But climate is different from weather because it is measured over a long period of time, whereas weather can change from day to day, or from year to year. The climate of an area includes seasonal temperature and rainfall averages, and wind patterns. Different places have different climates.

Climate change is the long-term alteration of temperature and typical weather patterns in a place. Climate change could refer to a particular location or the planet as a whole. Climate change may cause weather patterns to be less predictable. These unexpected weather patterns can make it difficult to maintain and grow crops in regions that rely on farming because expected temperature and rainfall levels can no longer be relied on. Climate change has also related to other damaging weather events such as more frequent and more intense hurricanes, floods, downpours, and winter storms

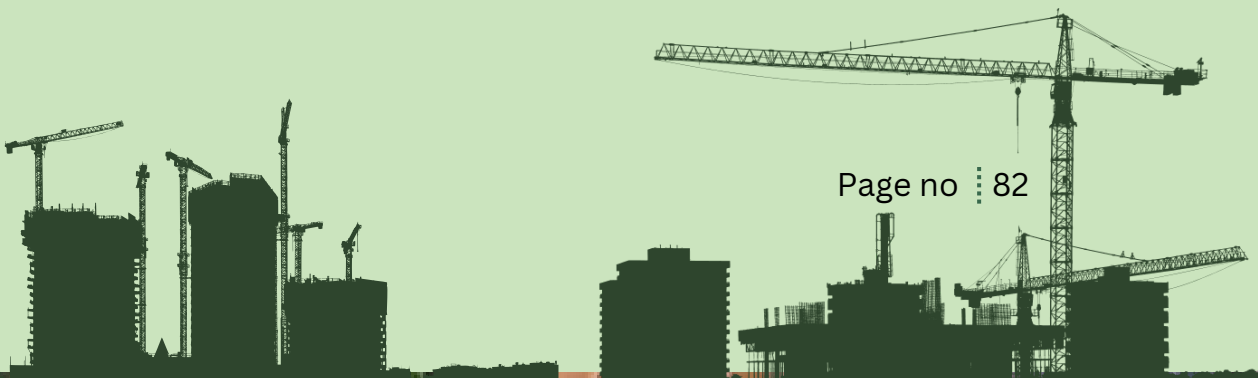



In Polar Regions, the warming global temperatures associated with climate change have meant ice sheets and glaciers are melting at an accelerated rate from season to season. This contributes to sea levels rising in different regions of the planet. Together with expanding ocean waters due to rising temperatures, the resulting rise in sea level has begun to damage coastlines as a result of increased flooding and erosion.

The cause of current climate change is largely human activity, like burning fossil fuels, like natural gas, oil, and coal. Burning these materials releases what are called greenhouse gases into Earth's atmosphere. There, these gases trap heat from the sun's rays inside the atmosphere causing Earth's average temperature to rise. This rise in the planet's temperature is called global warming. The warming of the planet impacts local and regional climates. Throughout Earth's history, climate has continually changed. When occurring naturally, this is a slow process that has taken place over hundreds and thousands of years. The human influenced climate change that is happening now is occurring at a much faster rate.

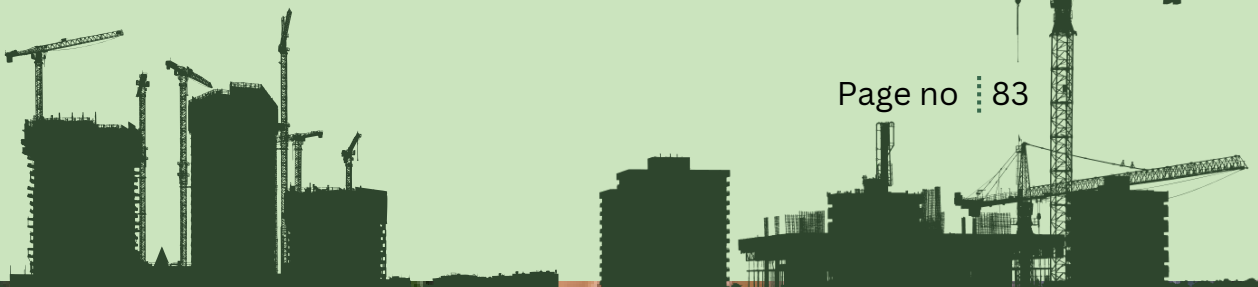

The main ways to stop climate change are to pressure government and business to: keep fossil fuels in the ground; invest in renewable energy; switch to suitable transport; improve farming; restore nature to absorb more carbon; protect forests and oceans; reduce plastic and so on. .



So, one of the important ways to protect the earth is to follow practices of sustainable development. UN also has developed 17 sustainable development goals as 2030 agenda for the world.

There is still hope of avoiding the worst consequences of climate change. Around the world, millions of us are taking steps to defend our climate. Tens of thousands of school strikers and people from all walks of life have taken to the streets demanding a solution to the climate emergency. It's in our hands to make this place a better place to live

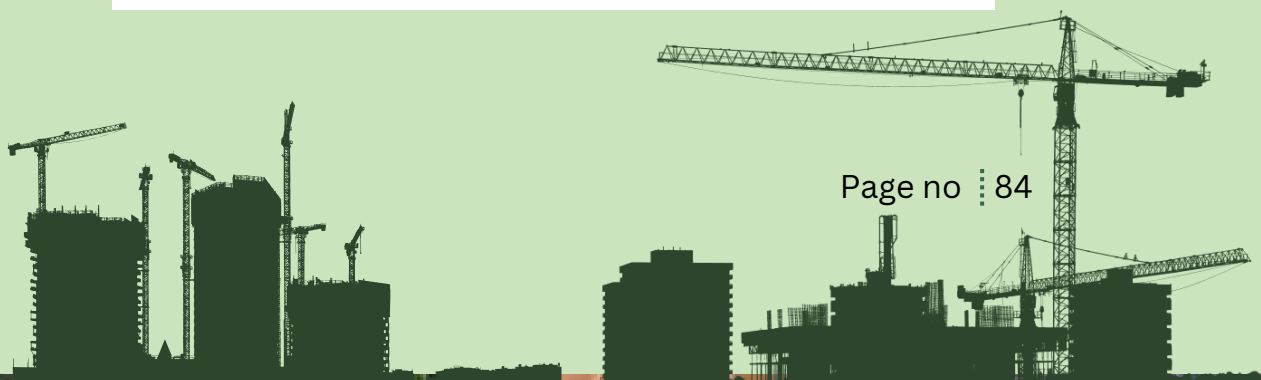



# Pencil Sketch of Civil Engineering Department

## Karthick I year Civil Engineering

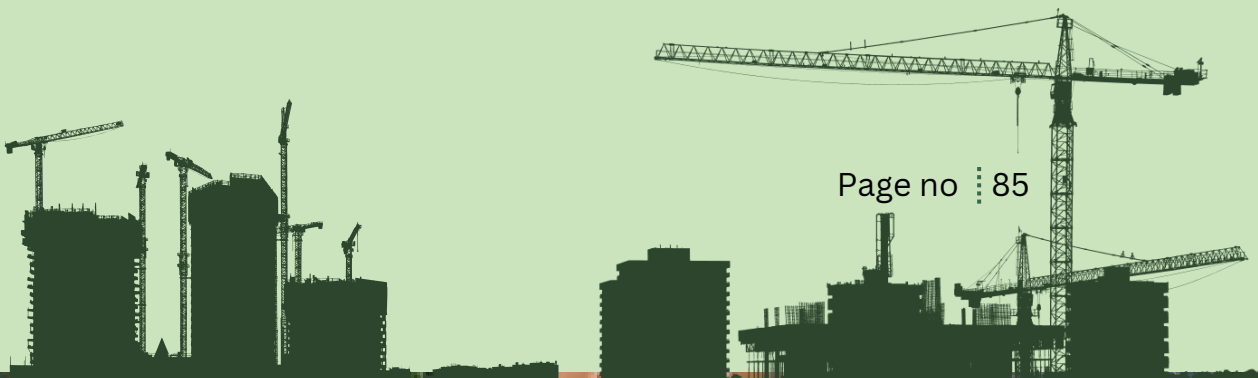
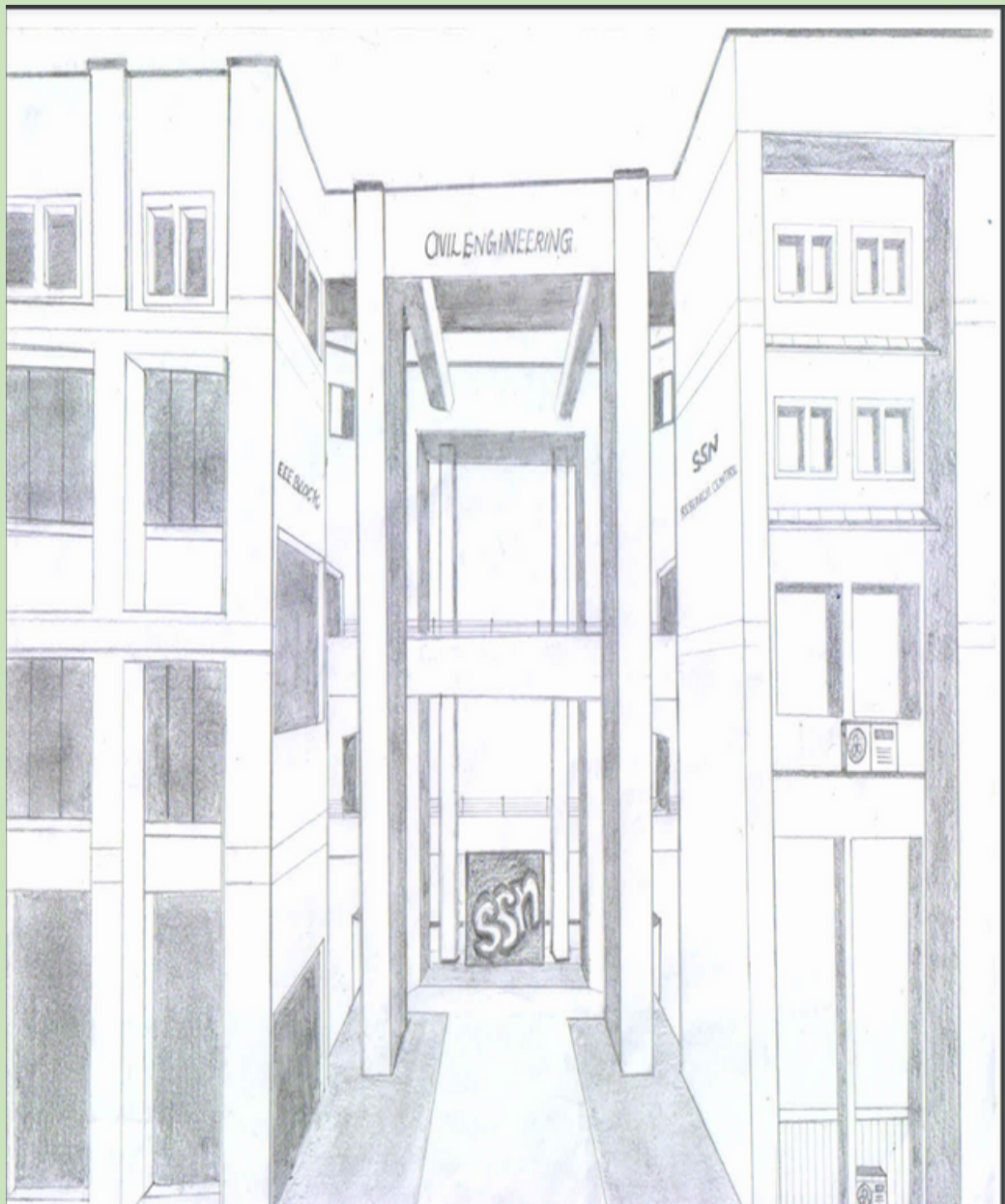

## 14 ALUMINI WRITE UP



**K. Sudesh Civil Engineering Alumni (2012 - 2016) batch**

**Hey all. Hope you are all doing great. This is K. Sudesh from Civil Dept (2012 - 16) batch. Currently working in Aspen Creations LLC as a Site Manager – SeaWorld, Abu Dhabi.**

**SSN has played a very crucial role in shaping my career. Its vision of shaping lives through quality education makes it stand tall apart from the other institutions.**

**Apart from the fact that SSN has the highest educational standards, management, staff and more, I would always be grateful to SSN for giving me multi-dimensional learning with an immense exposure that helped me kickstarting my career and continuing to drive me in reaching better positions.**

**The faculty is excellent with deep knowledge of every subject as well as beyond the subject. The experience here turned me into a more curious and achieving person.**

**I must say SSN is one of the finest colleges in its cadre and I feel proud to be an alumnus of SSN.**

**Sudesh Krishnakumar  
Phone: +971-588085904  
Mobile: +91-9600348248**

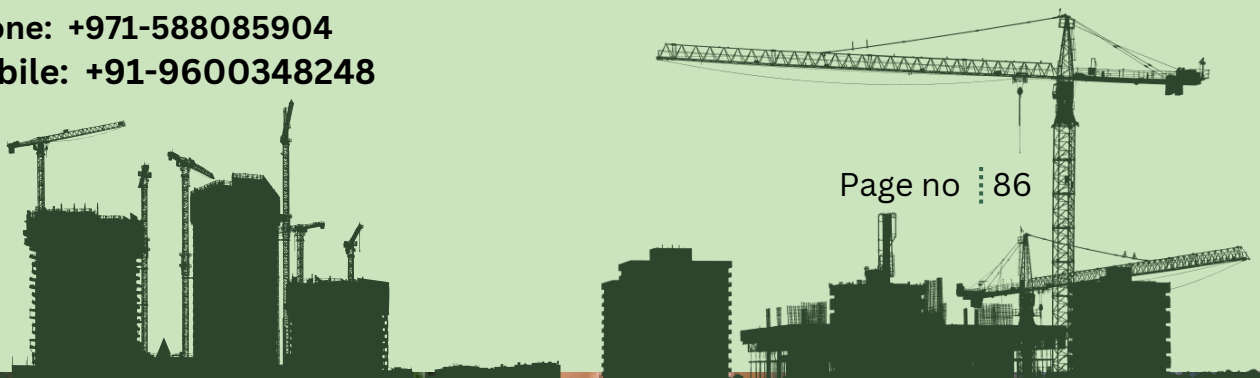

## 16. INDUSTRIAL ARTICLE

### Advanced Materials in Residential Construction David Arunraj B-Elegant Housing and Constructors

In recent times, there are more advanced materials used in the construction of residential buildings replacing the conventional materials they are not much costlier, provides good finishing and satisfactory End-Product.

Introduction of Self-Curing cement has good workability in plastering preventing shear cracks and requires no or very less curing compared to the convention OPC's and PPC's where they cannot prevent the shear cracks without any addition of admixtures. Also, the Self-Curing cement generally have the mixture in dry form and requires only the addition of water up to 6-7 liters per 40kg bag. Though 15% costlier than conventional cements they provide good finishing and customer satisfaction. There are more research going in developing this type of cement for concreting purpose also.



Manufacturing of Autoclaved Aerated Cement Blocks (AAC Blocks) this is a Swedish technology and an advanced material brought replacing conventional clay bricks, it has Fly-Ash or sand as its major constituent which has a smaller number of joints in construction than conventional clay brick which provides less plastering work, speedy construction and readily available in all seasons as clay bricks cannot be manufactured in the monsoon season. We have encountered a site where plaster on one side was not permitted by the neighbour so we used this material on that side and just closed the joints without plastering and it worked there wasn't any leakage or water seepage for now. Though it has a number of advantages like thermal insulation, light weight etc. it does not provide satisfaction to the customer when used in construction.

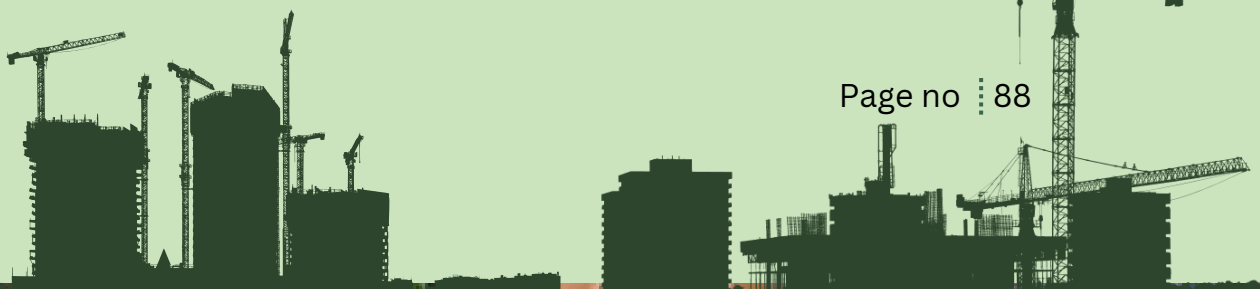
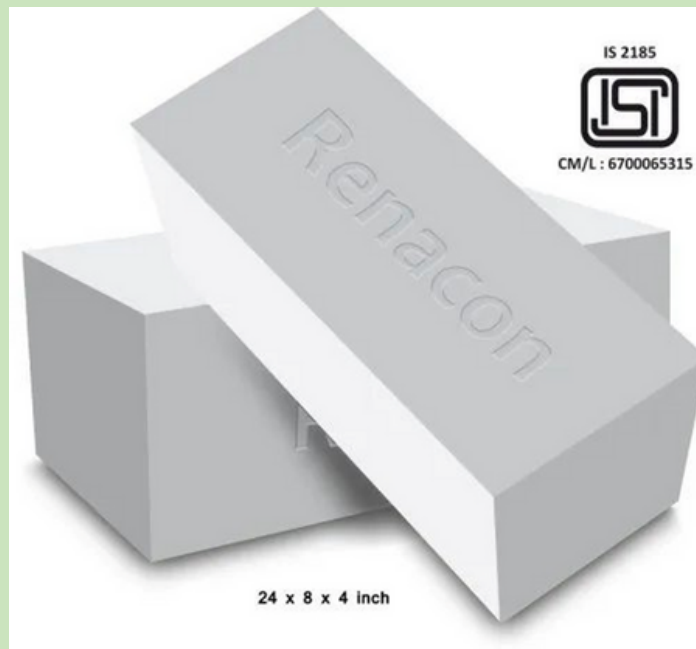

## EDITORIAL MEMBERS



**Chief Editor  
Dr.N. Sivakumar**

**Faculty coordinator  
Dr. Surendar Natarajan**





**Design Head**  
**Jewison Jacob-II year.**

**Editors** →



**Magendra Kamalnath-III year**

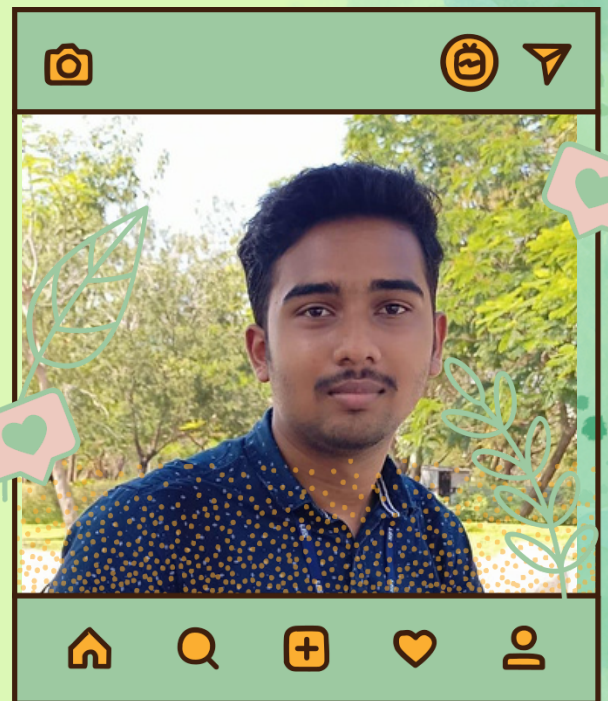

**M. Naresh III year**



## Content writing team

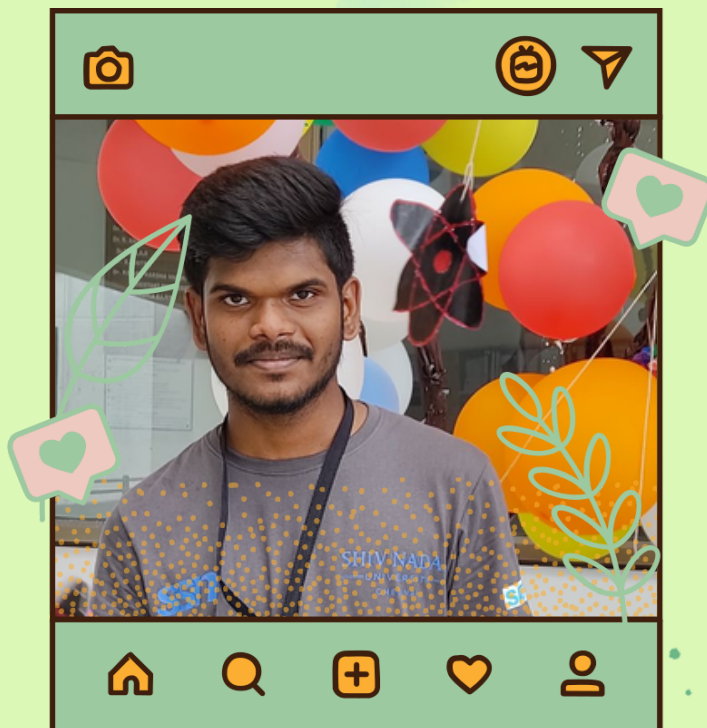

Raviraam S II year

## Design



Sasurudha M  
I year



Heman S  
i year

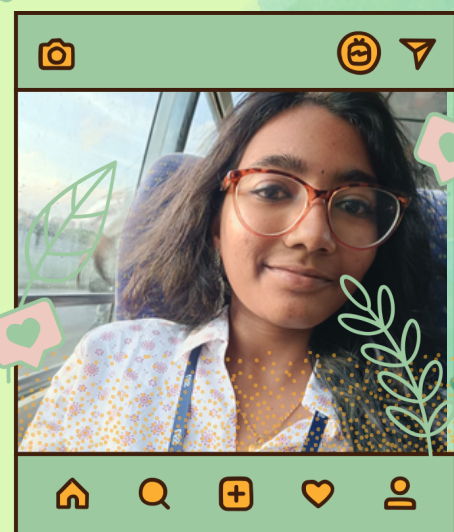

Harini S  
i year